

TX-8211

FM Stereo/AM Receiver

Instruction Manual

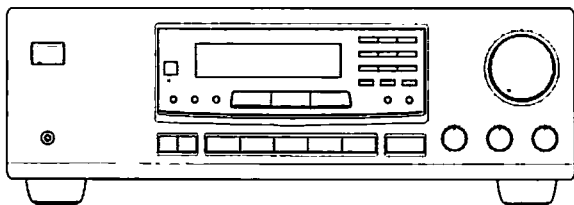

European and some other models

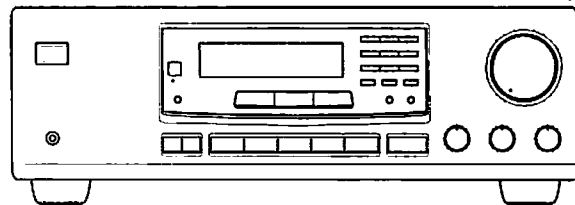

Other models

CONTENTS	
Features	2
Important safeguards	3
Precautions	4
Supplied accessories	4
Before operating this unit	5
Control positions and names	6
Making system connections	8
Connecting antennas	10
Connecting the power	12
Basic operations	13
Receiving stations	15
Receiving RDS (Only for European and some other models)	18
Recording a source	20
Using TAPE 2 MONITOR	21
Troubleshooting guide	22
Specifications	23

Thank you for purchasing the Onkyo TX-8211 FM Stereo/AM Receiver. Please read this manual thoroughly before making connections and operating the unit. Following the instructions in this manual will enable you to obtain optimum performance and listening enjoyment from your new Receiver. Please retain this manual for future reference.

Features

- **Power output**
 - USA & Canadian models:
 - 50 watts per channel, min RMS, at 8 ohms, both channels driven from 20 Hz to 20 kHz, with no more than 0.08% THD.
 - European models:
 - 2 x 70 watts at 4 ohms, 1 kHz (DIN)
 - Asian models:
 - 2 x 90 watts at 4 ohms, 1 kHz (EIAJ)
- Discrete output stage circuits for true high-current, low-impedance drive
- Costly, high-quality parts such as large power transistors, an oversized isolated transformer and heavy-duty extruded heat sink makes it possible to accurately and effortlessly drive 4-ohm speakers (rare for a receiver)
- 4 Audio inputs
- A/B Speaker selector and outputs
- Cassette tape dubbing capability
- Selective tone control
- 2-Mode APR (Automatic Precision Reception) (local/DX, auto/mono)
- 30 FM/AM random presets
- Preset scan tuning
- 3 Station group presets (10 stations per group)
- RDS with PS, PTY, RT, TP (European and some other models only)
- Direct access tuning
- Motor-driven, precision volume control
- Headphone jack
- Audio mute, sleep timer (via remote)
- Battery-free memory backup
- New non-resonant feet
- New slip-free rotary volume knob
- **RI** Compatible remote control

FOR U.S.A. MODEL

Note to CATV system installer:

- This reminder is provided to call the CATV system installer's attention to Section 820-40 of the NEC which provides guidelines for proper grounding and, in particular, specifies that the cable ground shall be connected to the grounding system of the building, as close to the point of cable entry as practical.

FOR CANADIAN MODEL POUR LE MODELE CANADIEN

- For models having a power cord with a polarized plug.
CAUTION: TO PREVENT ELECTRIC SHOCK, MATCH WIDE BLADE OF PLUG TO WIDE SLOT, FULLY INSERT.

- Sur les modèles dont la fiche est polarisée.
ATTENTION: POUR ÉVITER LES CHOCS ÉLECTRIQUES, INTRODUIRE LA LAME LA PLUS LARGE DE LA FICHE DANS LA BORNE CORRESPONDANTE DE LA PRISE ET POUSSER JUSQU'AU FOND.

FOR EUROPEAN MODEL

Declaration of Conformity

We, ONKYO EUROPE
ELECTRONICS GMBH
INDUSTRIESTRASSE 18/20
82110 GERMERING,
GERMANY



declare in own responsibility, that the ONKYO product described in this instruction manual is in compliance with the corresponding technical standards such as EN55013, EN55020, EN60555-2, EN60065

GERMERING, GERMANY

H. YAMAZOE

ONKYO EUROPE ELECTRONICS GMBH

ATTENTION FOR BRITISH MODEL

Replacement and mounting of an AC plug on the power supply cord of this unit should be performed only by qualified service personnel.

IMPORTANT:

The wires in the mains lead are coloured in accordance with the following code:

Blue: Neutral

Brown: Live

As the colours of the wires in the mains lead of this appliance may not correspond with the coloured markings identifying the terminals in your plug, proceed as follows:

The wire which is coloured BLUE must be connected to the terminal in the plug which is marked with the letter N or coloured BLACK.

The wire which is coloured BROWN must be connected to the terminal in the plug which is marked with the letter L or coloured RED.

IMPORTANT

A 5 amp fuse is fitted in this plug. Should the fuse need to be replaced please ensure that the replacement fuse has a rating of 5 amps and that it is approved by ASTA or BSI to BS 1362. Check for the ASTA mark or the BSI mark on the body of the fuse.

IF THE FITTED MOULDED PLUG IS UNSUITABLE FOR THE SOCKET OUTLET IN YOUR HOME THEN THE FUSE SHOULD BE REMOVED AND THE PLUG CUT OFF AND DISPOSED OF SAFELY. THERE IS A DANGER OF SEVERE ELECTRICAL SHOCK IF THE CUT OFF PLUG IS INSERTED INTO ANY 13 AMP SOCKET.

If in any doubt please consult a qualified electrician.

“WARNING”

“TO REDUCE THE RISK OF FIRE OR ELECTRIC SHOCK, DO NOT EXPOSE THIS APPLIANCE TO RAIN OR MOISTURE.”

CAUTION:

“TO REDUCE THE RISK OF ELECTRIC SHOCK, DO NOT REMOVE COVER (OR BACK). NO USER-SERVICEABLE PARTS INSIDE. REFER SERVICING TO QUALIFIED SERVICE PERSONNEL.”



WARNING

**RISK OF ELECTRIC SHOCK
DO NOT OPEN**



- The lightning flash with arrowhead symbol, within an equilateral triangle, is intended to alert the user to the presence of “dangerous voltage” within the product’s enclosure that may be of sufficient magnitude to constitute a risk of electric shock to persons.
- The exclamation point within an equilateral triangle is intended to alert the user to the presence of important operating and maintenance (servicing) instructions in the literature accompanying the product.

Important safeguards

1. **Read Instructions** – All the safety and operating instructions should be read before the appliance is operated.
2. **Retain Instructions** – The safety and operating instructions should be retained for future reference.
3. **Heed Warnings** – All warnings on the appliance and in the operating instructions should be adhered to.
4. **Follow Instructions** – All operating and use instructions should be followed.
5. **Water and Moisture** – The appliance should not be used near water – for example, near a bathtub, washbowl, kitchen sink, laundry tub, in a wet basement, or near a swimming pool, and the like.
6. **Carts and Stands** – The appliance should be used only with a cart or stand that is recommended by the manufacturer.

- 6A. An appliance and cart combination should be moved with care. Quick stops, excessive force, and uneven surfaces may cause the appliance and cart combination to overturn.

PORTABLE CART WARNING



S3125A

7. **Wall or Ceiling Mounting** – The appliance should be mounted to a wall or ceiling only as recommended by the manufacturer.
8. **Ventilation** – The appliance should be situated so that its location or position does not interfere with its proper ventilation. For example, the appliance should not be situated on a bed, sofa, rug, or similar surface that may block the ventilation openings; or if placed in a built-in installation, such as a book case or cabinet that may impede the flow of air through the ventilation openings, there should be free space of at least 20 cm and open up behind the appliance.
9. **Heat** – The appliance should be situated away from heat sources such as radiators, heat registers, stoves, or other appliances (including amplifiers) that produce heat.
10. **Power Sources** – The appliance should be connected to a power supply only of the type described in the operating instructions or as marked on the appliance.
11. **Polarization** – If the appliance is provided with a polarized plug having one blade wider than the other, please read the following information: The polarization of the plug is a safety feature. The polarized plug will only fit the outlet one way. If the plug does not fit fully into the outlet, try reversing it. If there is still trouble inserting it, the user should seek the services of a qualified electrician. Under no circumstances should the user attempt to defeat the polarization of the plug.
12. **Power-Cord Protection** – Power-supply cords should be routed so that they are not likely to be walked on or pinched by items placed upon or against them, especially near plugs, convenience receptacles, and the point where they exit from the appliance.
13. **Cleaning** – The appliance should be cleaned only as recommended by the manufacturer.

14. **Power Lines** – An outdoor antenna should be located away from power lines.
15. **Nonuse Periods** – The power cord of the appliance should be unplugged from the outlet when left unused for a long period of time.
16. **Object and Liquid Entry** – Care should be taken so that objects do not fall and liquids are not spilled into the enclosure through openings.
17. **Damage Requiring Service** – The appliance should be serviced by qualified service personnel when:
 - A. The power-supply cord or the plug has been damaged; or
 - B. Objects have fallen, or liquid has been spilled into the appliance; or
 - C. The appliance has been exposed to rain; or
 - D. The appliance does not appear to operate normally or exhibits a marked change in performance; or
 - E. The appliance has been dropped, or the enclosure damaged.
18. **Servicing** – The user should not attempt to service the appliance beyond that described in the operating instructions. All other servicing should be referred to qualified service personnel.
19. **Outdoor Antenna Grounding** – If an outside antenna is connected to the receiver, be sure the antenna system is grounded so as to provide some protection against voltage surges and built up static charges. Article 810 of the National Electrical Code, ANSI/NFPA 70, provides information with regard to proper grounding of the mast and supporting structure, grounding of the lead-in wire to an antenna discharge unit, size of grounding conductors, location of the antenna-discharge unit, connection to grounding electrodes, and requirements for the grounding electrode. See Figure 73.1.

FIGURE 73.1:
EXAMPLE OF ANTENNA GROUNDING AS PER
NATIONAL ELECTRICAL CODE

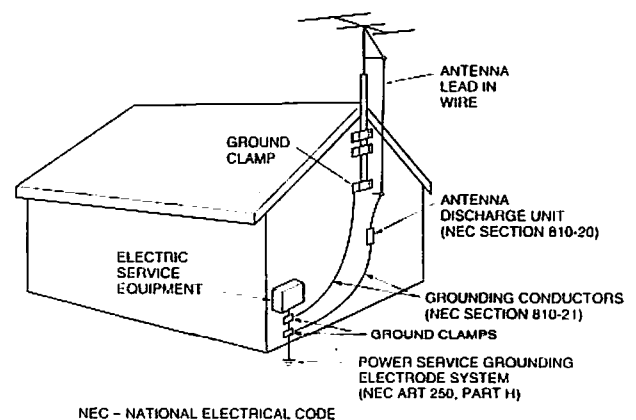

S2898A

Precautions

1. Warranty Claim

You can find the serial number on the rear panel. In case of warranty claim, please report this number.

2. Recording Copyright

Recording of copyrighted material for other than personal use is illegal without permission of the copyright holder.

3. AC Fuse

The fuse is located inside the chassis and is not user-serviceable. If power does not come on, contact your Onkyo authorized service station.

4. Care

From time to time you should wipe the front and rear panels and the cabinet with a soft cloth. For heavier dirt, dampen a soft cloth in a weak solution of mild detergent and water, wring it out dry, and wipe off the dirt. Following this, dry immediately with a clean cloth. Do not use rough material, thinners, alcohol or other chemical solvents or cloths since these could damage the finish or remove the panel lettering.

5. Power

WARNING

BEFORE PLUGGING IN THE UNIT FOR THE FIRST TIME, READ THE FOLLOWING SECTION CAREFULLY.

- Some models are designed for use only with the power supply voltage of the region where they are sold.
 - European and Australian models: AC 230V, 50Hz
 - U.S. and Canadian models: AC 120V, 60Hz
 - Worldwide model: AC 220-230V/120V switchable, 50/60Hz
 - Other: AC 220V, 60Hz
- Voltage Selector (Rear Panel)**
Worldwide models are equipped with a voltage selector to conform to local power supplies. Be sure to set this switch to match the voltage of the power supply in your area before plugging in the unit. (See page 5.) Models without a voltage selector can only be used in areas where the power supply is the same as that of the unit.
- The power does not shut off completely by just turning the power off. So power cord should be removed from AC outlet when not in use for a prolonged time.

Memory Preservation

This unit does not require memory preservation batteries. A built-in memory power back-up system preserves the contents of the memory during power failures and even when the unit is unplugged. The unit must be plugged in order to charge the back-up system.

The memory preservation period after the unit has been unplugged varies depending on climate and placement of the unit. On the average, memory contents are protected over a period of a few weeks after the last time the unit has been unplugged. This period is shorter when the unit is exposed to a highly humid climate.

Supplied accessories

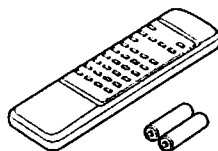

Remote control RC-330S (1)
Battery (size AA, R6, or UM-3) (2)

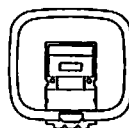

AM loop antenna (1)



T-shaped FM antenna (1)

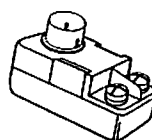

(worldwide and some other models)
75/300 ohm
antenna adaptor (1)

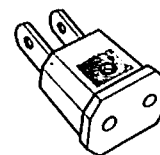

(worldwide model only)
Conversion plug
(Shape may vary
according to the area
where purchased.) (1)

Before operating this unit

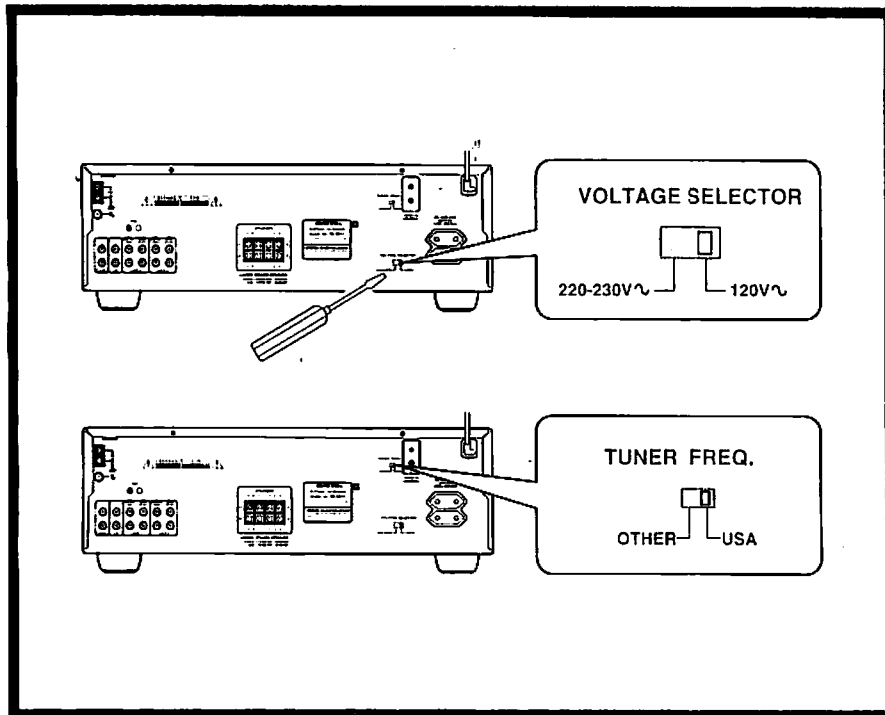

Setting the voltage selector (worldwide model only)

1. Determine the proper voltage for your area: 220 ~ 230 V or 120 V.
2. If the setting on the voltage selector is not correct, insert a screwdriver into the groove in the switch and slide the switch completely to the right (120 V) or the left (220 ~ 230 V), whichever is appropriate.

Setting the tuning step frequency (worldwide model only)

The worldwide model is equipped with a switch that controls the AM (9 kHz/10 kHz) band tuning steps.

Please set this switch to match the tuning step frequency in your area.

U.S. & Canada:	USA
Other areas:	OTHER

Using the remote control

The following information will help you get optimal use from the remote control.

- Place this unit away from direct bright light which can prevent proper operation of the remote control.
- Make sure audio rack doors do not have tinted glass. Placing this unit behind such a door may prevent proper remote control operation.

Loading the batteries

Remove the battery compartment cover by opening it as shown in the illustration. Load two AA (R6 or UM-3)-size batteries into the remote control with the plus (+) and minus (-) terminals positioned as indicated by the diagram inside the battery compartment, then close the cover.

- Immediately remove empty batteries to avoid corrosion damage.
- To avoid potential corrosion damage, never mix old batteries with new ones.
- The manganese batteries supplied with this unit have a service life of approximately six months, depending on the frequency of use.
- The TX-8211 comes equipped with two AA (R6 or UM-3) manganese batteries, but we recommend that long-life AA (LR6 or AM-3)-size alkaline batteries be used when replacing the batteries.

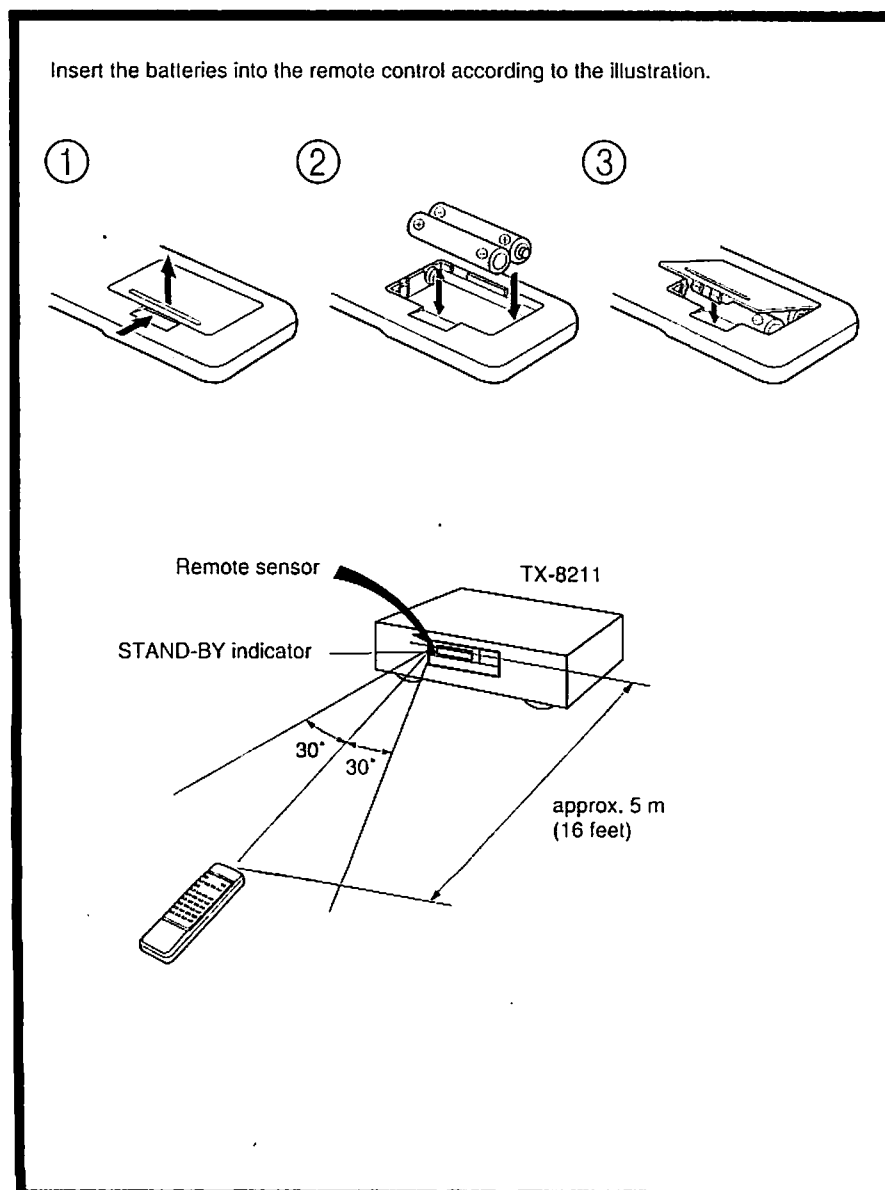

Control positions and names

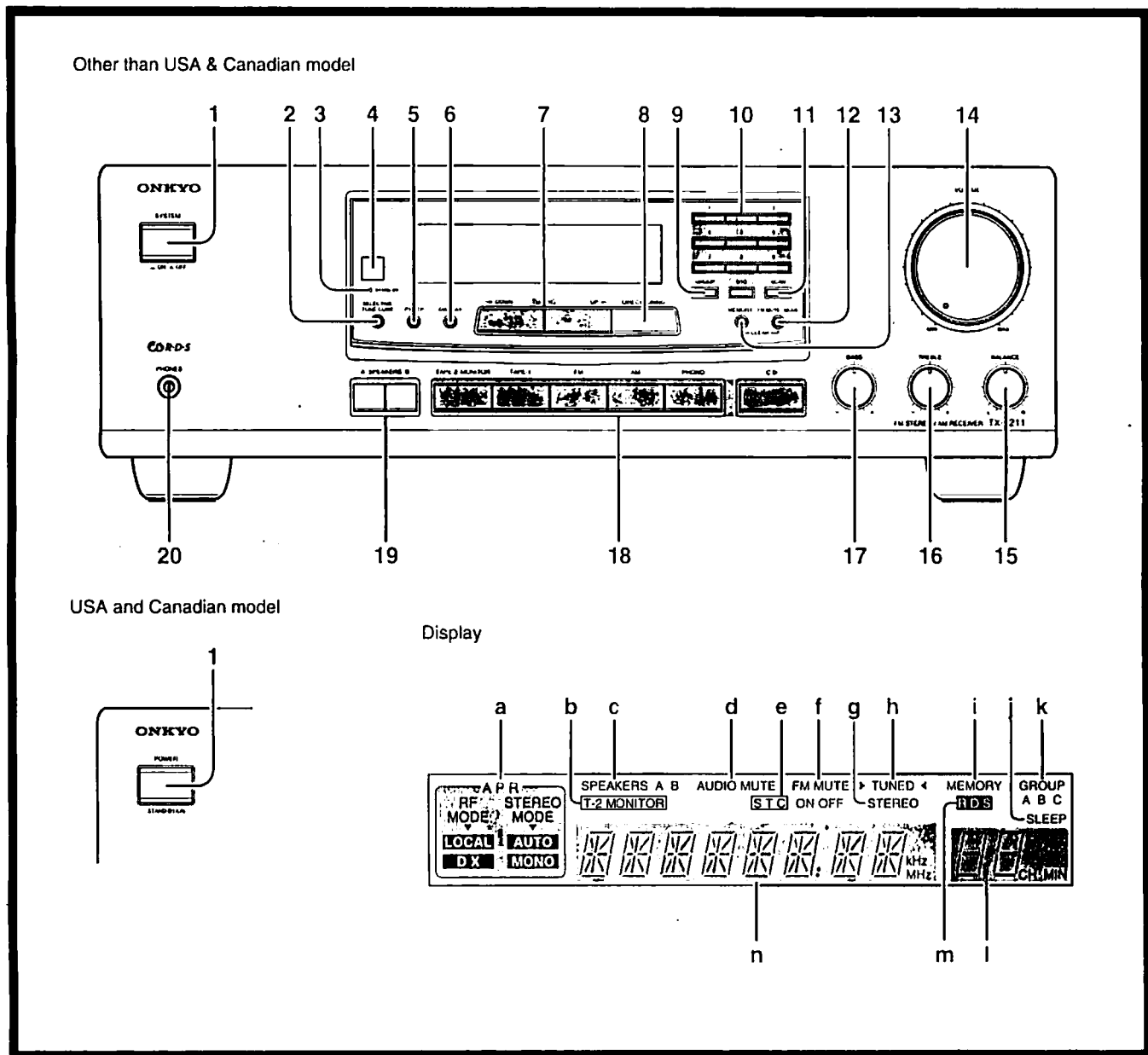

For more information about buttons or knobs, turn to the page number listed in [].

Front panel

1. POWER (or SYSTEM) switch [12]
2. SELECTIVE TONE CONT button [13]
3. STAND-BY indicator [12]
4. Remote sensor [5]
5. PTY/TP button [19]
(Only for European and some other models)
6. DISPLAY button [19]
(Only for European and some other models)
7. ◀ DOWN, UP ▶ TUNING buttons [15]
8. DIRECT TUNING button [15]
9. GROUP button [16, 17]
10. Number buttons [15-17]
11. SCAN button [17, 19]
12. FM MUTE/MODE button [16, 17]
13. MEMORY button [16, 17]
14. VOLUME knob [13]
15. BALANCE control knob [13]
16. TREBLE control knob [13]
17. BASS control knob [13]
18. Input selector buttons [13]
19. SPEAKERS A/B buttons [13]
20. Headphone jack [14]

Display

If there is a protective film on the surface of the display which is making it difficult to read the display, remove it.

- a. APR indicators

- b. T-2 MONITOR (Tape-2 Monitor) indicator
- c. Speaker selector indicators
- d. AUDIO MUTE indicator
- e. Selective Tone Control indicator
- f. FM MUTE ON/OFF indicator
- g. STEREO indicator
- h. TUNED indicator
- i. MEMORY indicator
- j. SLEEP indicator
- k. GROUP indicators
- l. Preset station/sleep timer display
- m. RDS indicator (Only for European and some other models)
- n. Multi function display

Control positions and names

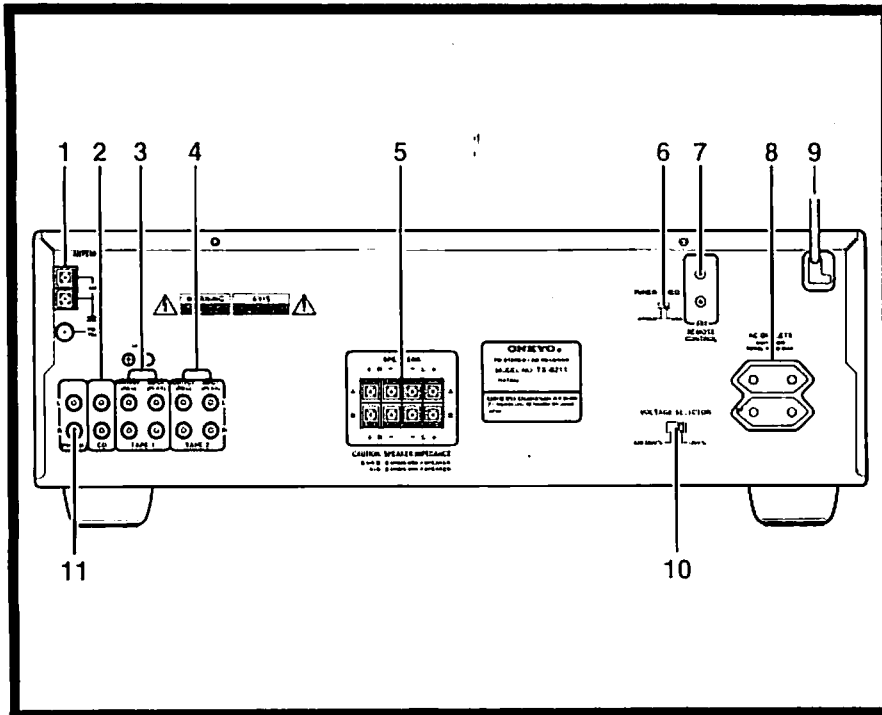

Rear panel

1. ANTENNA terminals [11]
2. CD input connectors [8]
3. TAPE-1/INPUT/OUTPUT connectors [8]
4. TAPE-2 INPUT/OUTPUT connectors [8]
5. SPEAKERS terminals [9]
6. TUNER FREQ. (Tuning Step Frequency) switch [5] (Worldwide model only)
7. REMOTE CONTROL connectors [8]
8. AC OUTLETS [9]
9. Power supply cord [12]
10. VOLTAGE SELECTOR [5] (Worldwide model only)
11. PHONO input connectors [8]

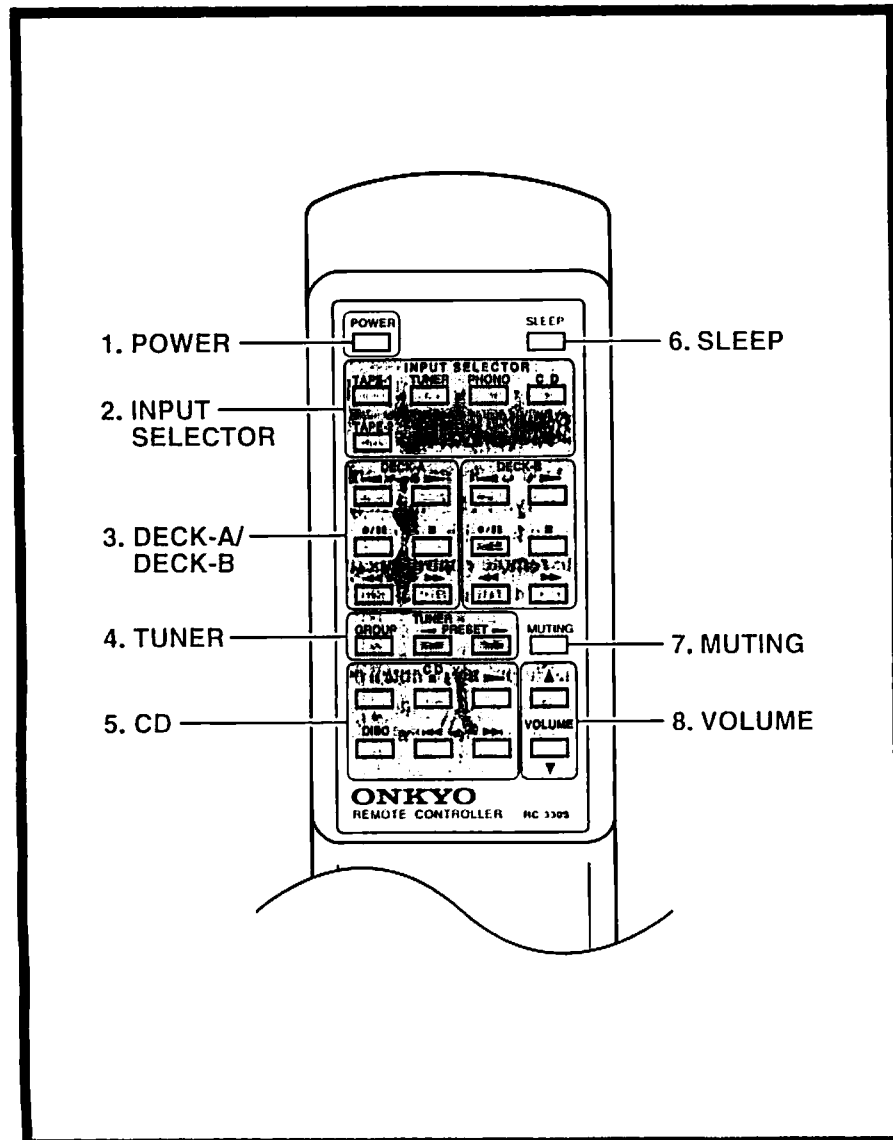

Remote Control

1. POWER button [12]
2. INPUT SELECTOR buttons [13]
4. TUNER operation buttons [17]
GROUP : Group button
◀PRESET ▶:Preset memory up/down buttons
6. SLEEP button [14]
7. MUTING button [14]
8. VOLUME ▲/▼ buttons [13]

When you have made the connections mentioned on page 8, you will be able to use the following buttons.

3. Tape deck operation buttons (DECK-A, DECK-B)

- ◀ : Reverse play button
- ▶ : Forward play button
- ◀◀ : Fast rewind button
- ▶▶ : Fast forward button
- : Stop button
- /|| : Rec/pause button

* When only a single deck is used, operate DECK-B.

5. CD player operation buttons (CD)

- : Stop button
- || : Pause button
- ▶ : Play button
- ◀◀ : Down button
- ▶▶ : Up button
- DISC : Disc button for CD changer

Making system connections

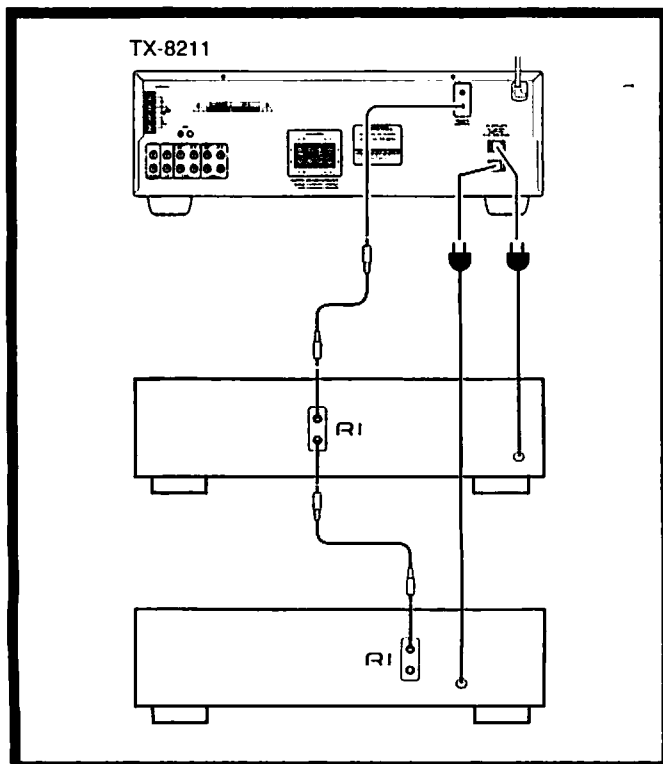
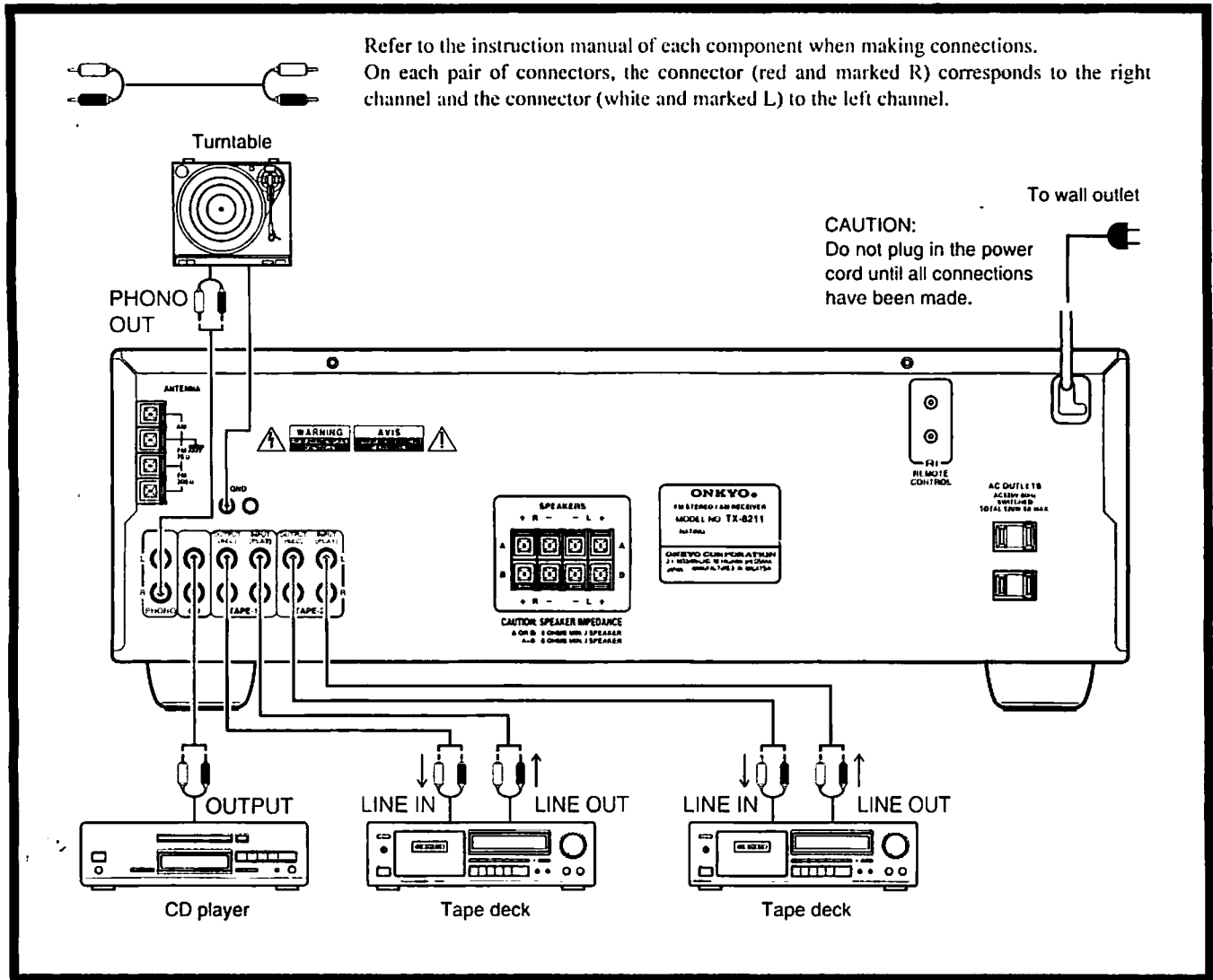

Remote control connections

Cassette tape decks and a compact disc player that are equipped with an Onkyo **RI** connector can be operated using the remote control included with this unit.

To enable remote control operation of other components, connect the remote control cable as shown at the left.

NOTE:

- To enable proper remote control operation, both the **RI** cables and the audio cables must be connected to the units.
- This unit's remote control cannot be used to control Onkyo turntables.
- An **RI** remote control cable equipped with 1/8" (3.5 mm) mini jacks is included with any other component installed with an **RI** connector.

Making system connections

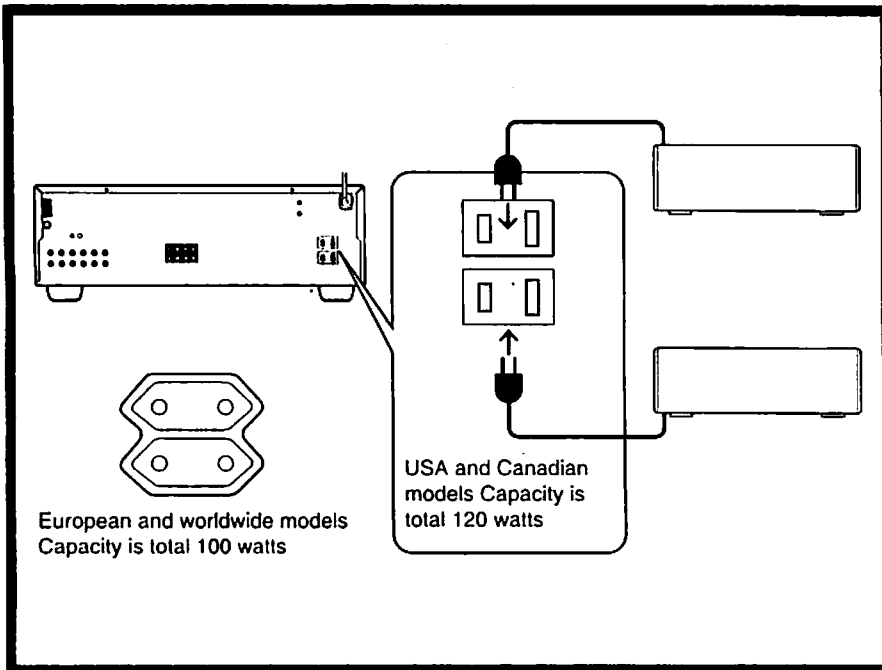

AC outlet connections

The power to components connected to the SWITCHED outlet is turned on and off using the POWER switch (or the SYSTEM switch on models other than USA and Canadian models) on the front panel and remote control.

NOTE:

- The shape, number and total capacity of the AC outlets may differ according to the model and the area where the unit is purchased. Be careful that other components connected to this unit do not exceed the capacity that is printed on the rear panel above the AC outlets.
- (For the European model)
The remote control cannot be used when the SYSTEM switch on the front panel is set to OFF.

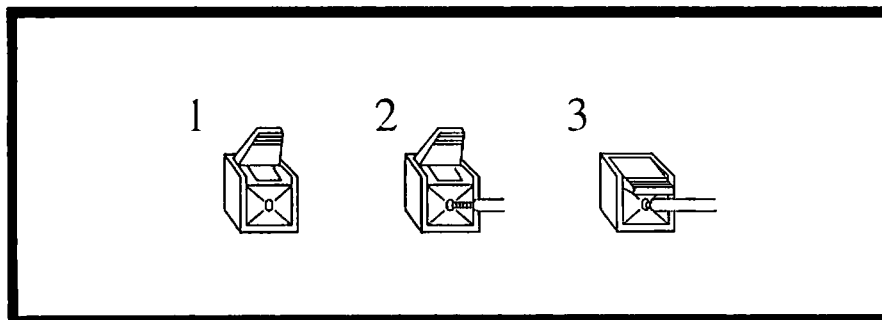

Connecting the speaker cables

1. Open the lever.
 2. Twist wire ends very tight, and insert the wire.
 3. Close the lever.
- Before making any connections, please refer to the explanation of "Speaker impedance".

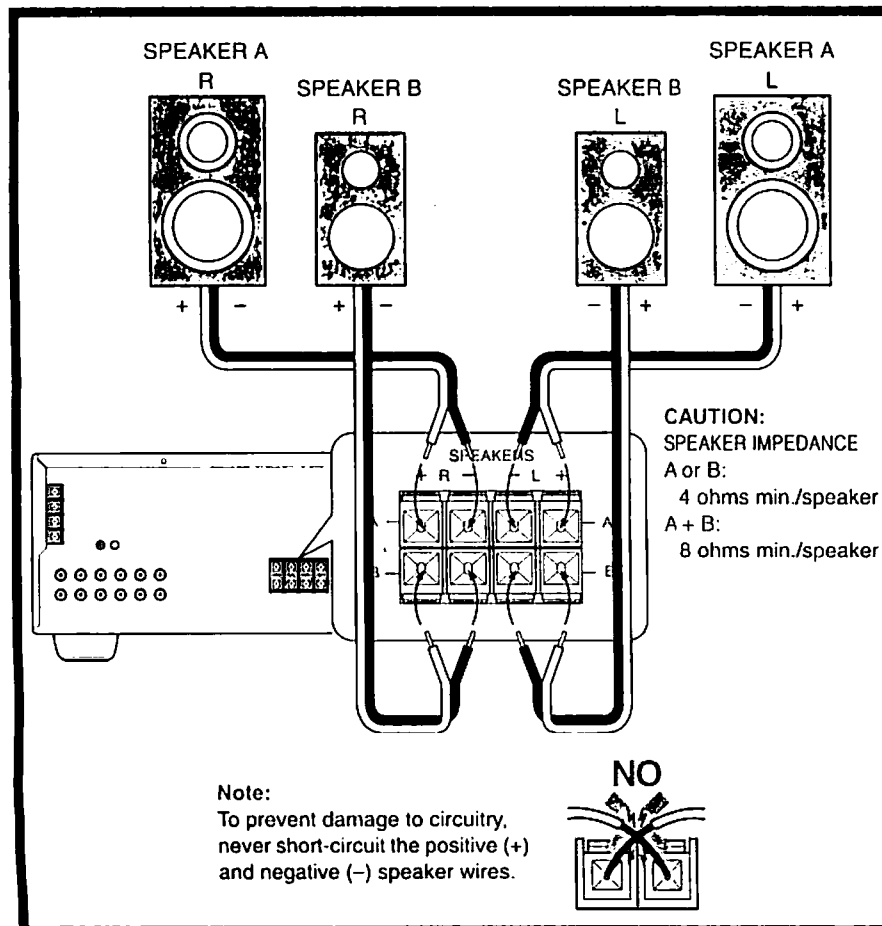

Connecting the speakers

Speaker Impedance
 The load impedance of each speaker system connected to this unit must be at least 4 ohms. (If using only A or only B, 4 ohms min.; if A and B, 8 ohms min.)

You can connect two separate pairs of speaker systems.

Please connect each speaker according to the illustration, observing the correct connections for R, L, + and -.

- Do not use unnecessarily long or extremely thin speaker leads. If the DC resistance of the speaker leads is too high, the damping factor will decrease, adversely affecting the sound quality.
- When using only one speaker or when you wish to listen to monaural (mono), the single speaker should never be connected in parallel to both the right and left channel terminals at the same time.

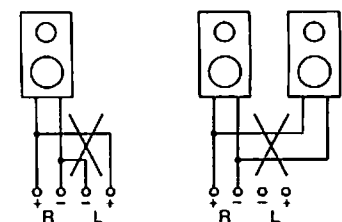

Connecting antennas

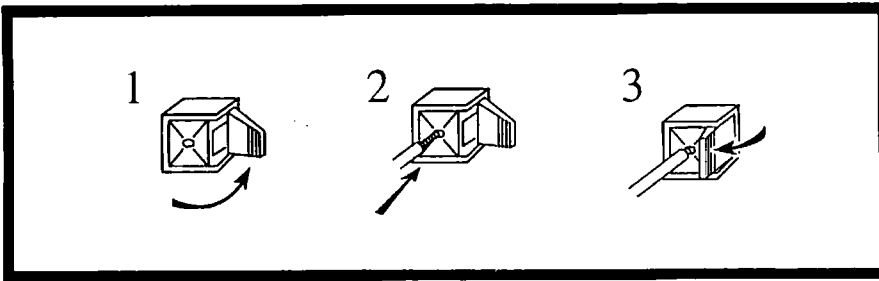

Antenna cables

1. Open the lever.
2. Twist wire ends very tight, and insert the wire.
3. Close the lever.

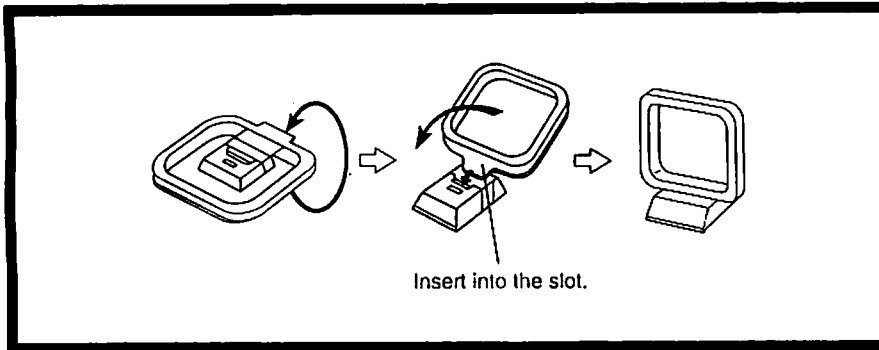

AM loop antenna

Assemble the loop antenna as shown in the illustration. (Refer to the next page for details on connecting the AM loop antenna.)

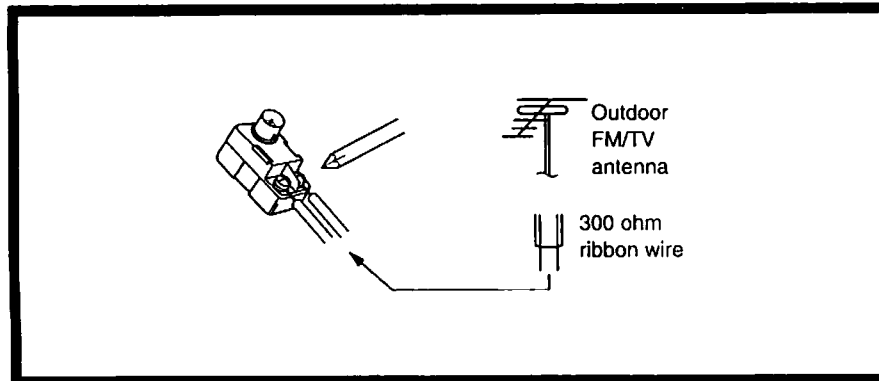

75/300 ohm adaptor (worldwide and some other models)

Connecting the 300 ohm ribbon wire to the 75/300 ohm adaptor
Loosen the screws and wrap the wires around them. Then, tighten the screws with a screwdriver.

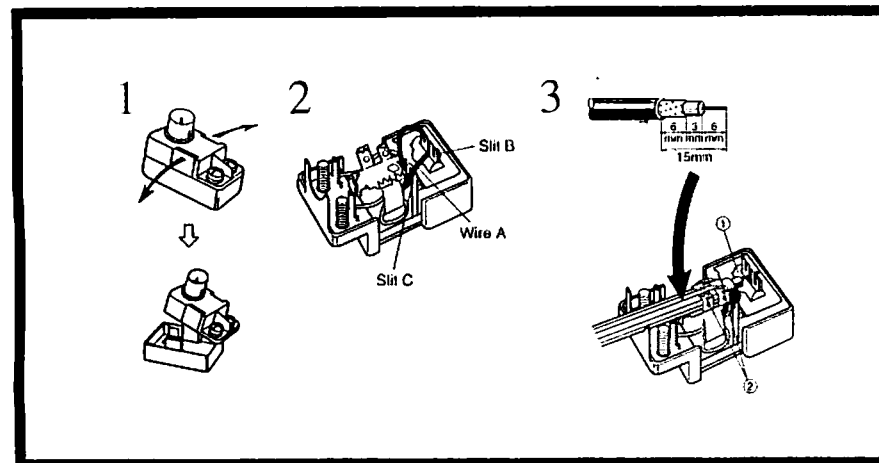

Connecting the coaxial cable to the 75/300 ohm adaptor

1. With a small screwdriver, pull the stoppers outwards and remove the cover.
2. Remove the transformer wire A from slit B and insert it into slit C.
3. Prepare the coaxial cable as shown in the illustration. Connect the coaxial cable to the 75/300 ohm antenna adaptor.
 - ① Insert the end of the cable.
 - ② Use pliers to pinch it and keep it in place.
4. Re-install the cover.

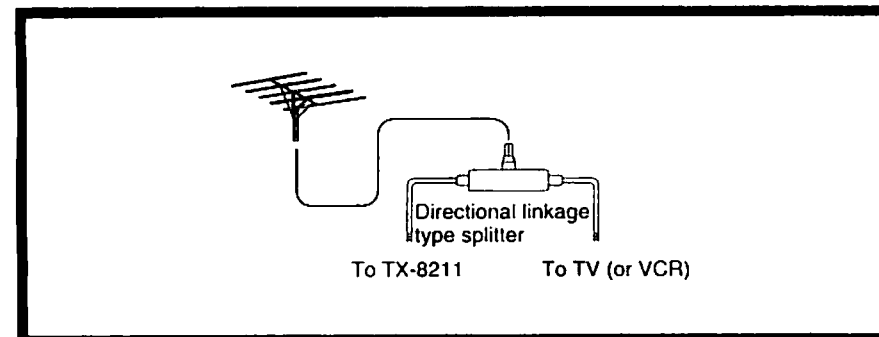

Directional linkage

Do not use the same antenna for both FM and TV (or VCR) reception since the FM and TV (or VCR) signals can interfere with each other. If you must use a common FM/TV (or VCR) antenna, use a directional linkage type splitter.

Connecting antennas

T-shaped FM antenna and AM loop antenna

The T-shaped FM antenna is for indoor use only. Extend the antenna and move it until the clearest signal is received. Use tacks or similar objects to fix it in the T-shaped arrangement giving the least amount of distortion.

The AM loop antenna is also for indoor use only. Position it where the clearest sound is received. Put it as far as possible away from this unit, the TV, speaker cables and power cords.

If clear signals cannot be received using only the enclosed T-shaped FM antenna or AM loop antenna, connect an outdoor FM or outdoor AM antenna as needed.

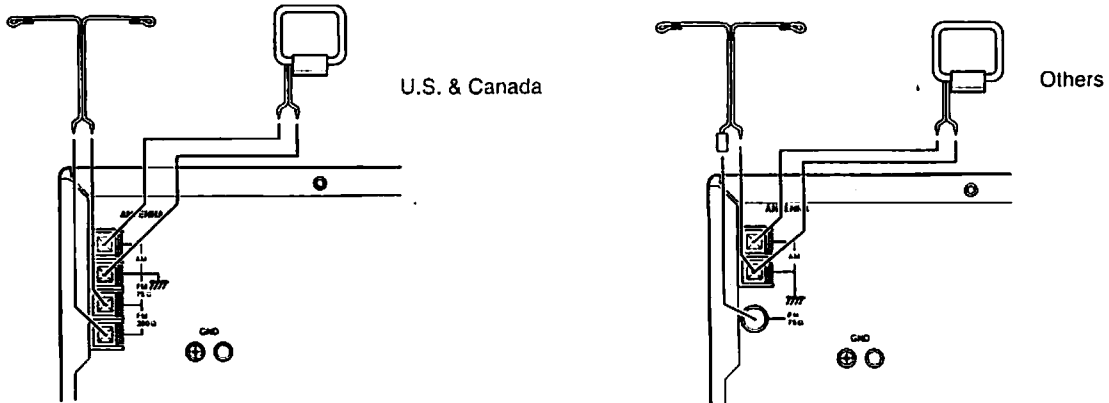

Outdoor AM antenna

The outdoor AM antenna will be more effective if it is stretched horizontally above a window or outside. (Do not disconnect the AM loop antenna.)

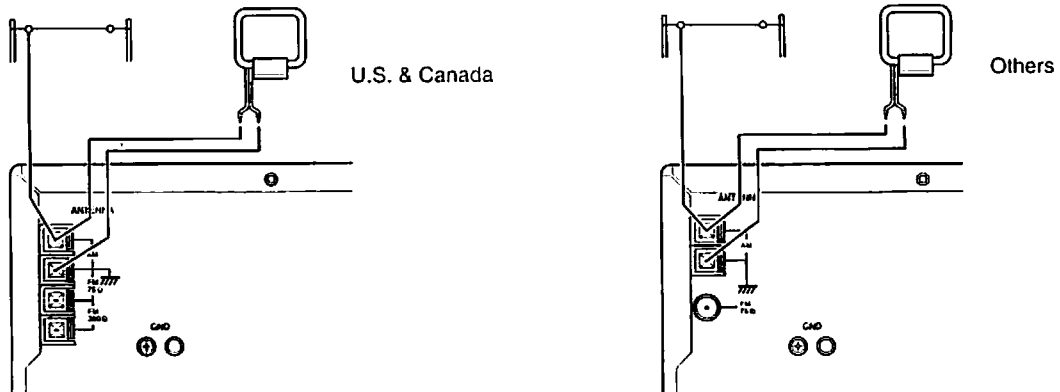

Outdoor FM antenna

Be sure that the outdoor FM antenna is positioned as follows:

- Keep the antenna away from noise sources, such as neon signs and busy roads.
- Do not position it near power lines, etc. This is very dangerous.

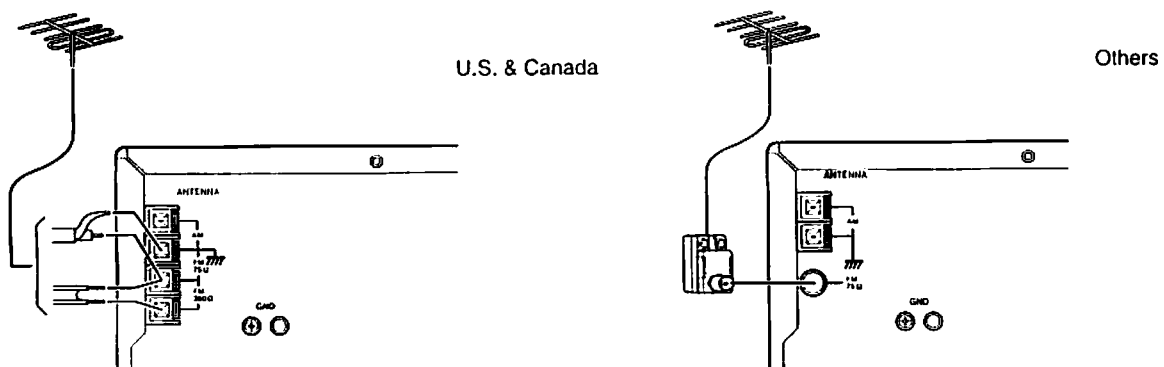

Connecting the power

Before plugging in the unit, confirm that all connections have been made properly.

Before turning on the power, be sure that the VOLUME knob is fully turned counterclockwise.

Turning on this unit's power may cause a momentary power surge, which might interfere with other electrical equipment, such as computers. If so, use a wall outlet on a different circuit.

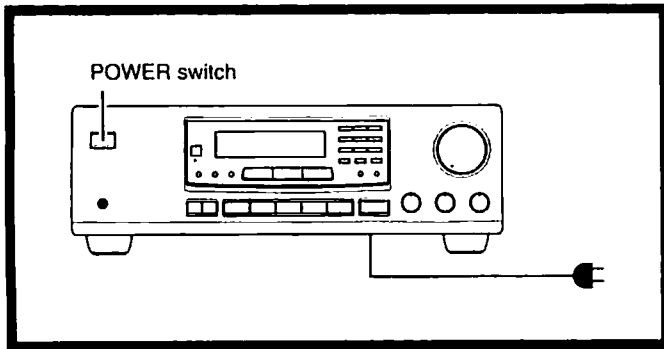

U.S. and Canadian models:

Plugging the TX-8211's power cord into an AC outlet puts the unit in stand-by status (the STAND-BY indicator is lit). Pressing the POWER switch turns on the unit and lights up the display. If this switch is pressed again, the unit returns to the stand-by status. The POWER button on the remote control is used in the same way as the POWER switch on the TX-8211.

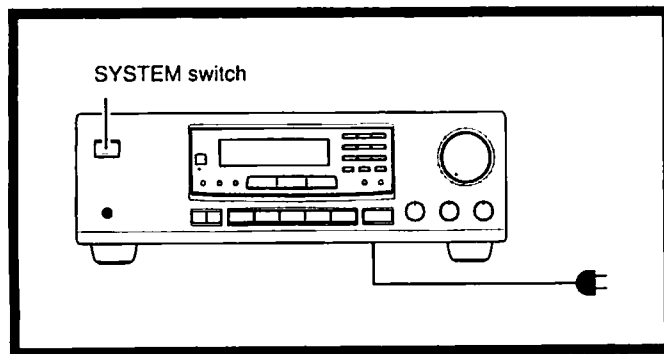

Models other than U.S. and Canadian models:

After plugging the TX-8211's power cord into an AC outlet, press the SYSTEM switch to put the unit in power-on status (the unit can be operated and its display is lit). The remote control cannot be used to operate the TX-8211 if the SYSTEM switch is not set to ON.

When the SYSTEM switch is set to ON, pressing the POWER button on the remote control switches the TX-8211 between stand-by status (the STAND-BY indicator is lit) and power-on status (the display will light up).

Pressing the SYSTEM switch on the TX-8211 to set it to OFF turns off the unit. (When the SYSTEM switch is set to OFF, only a small amount of power is used.)

Basic operations

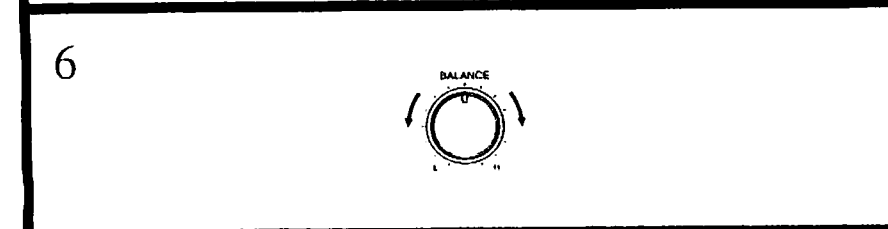
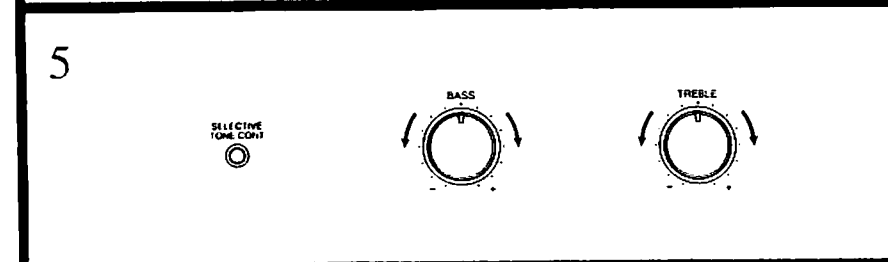
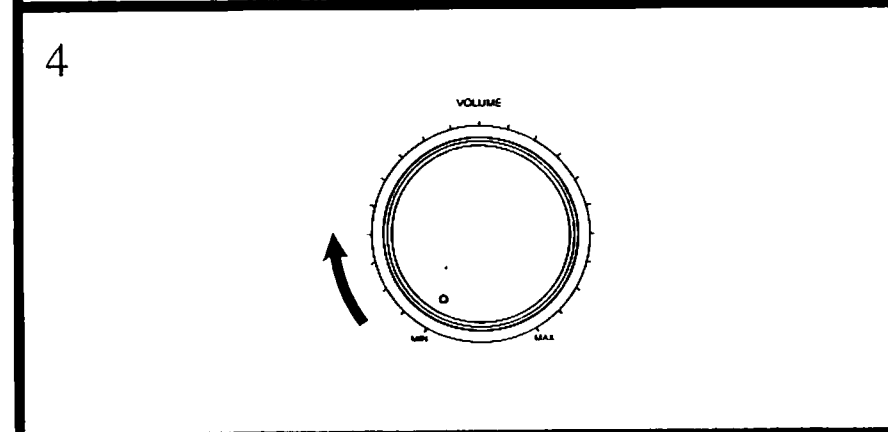
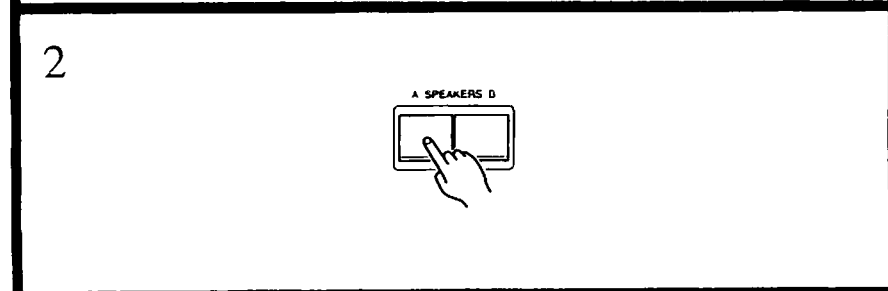
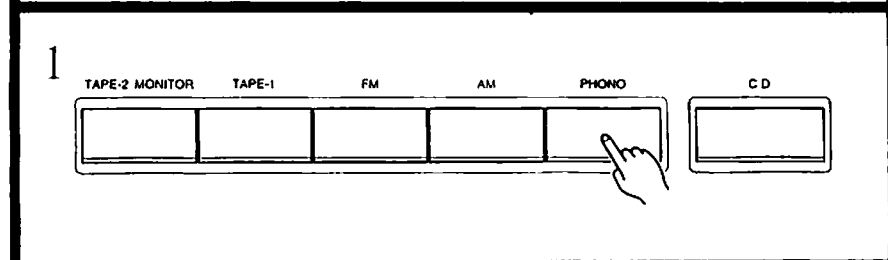
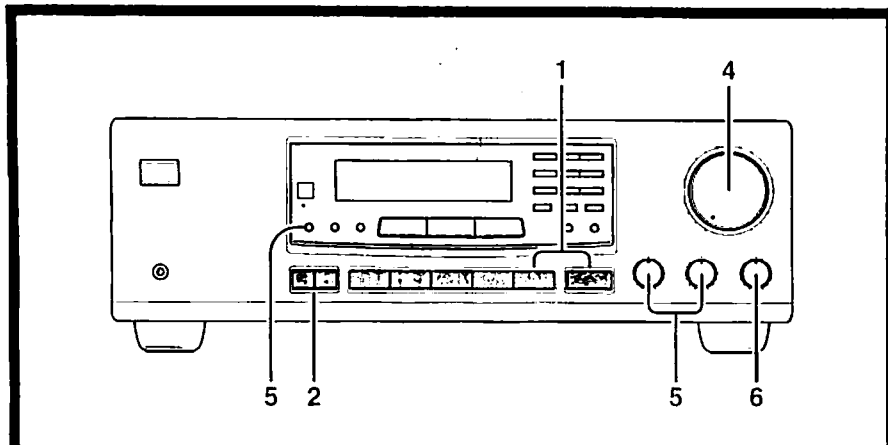

Listening to your favorite source

1. Select the source you wish to listen to using the input selector (e.g. PHONO). Confirm that the **T-2 MONITOR** indicator is not lit when a source other than TAPE-2 MONITOR has been selected. Also check that the **AUDIO MUTE** indicator is not lit.
2. Select the speakers. Select and press the button for the speakers that you want to listen to (SPEAKERS A and/or SPEAKERS B). The corresponding A and/or B indicator lights up on the display panel. You will hear from the speakers any sound going through this unit. If both SPEAKERS (A and B) are set to OFF, no sound will come from the speakers.
3. Start playing the selected input source. Follow the operating instructions for that unit. If FM or AM is selected, refer to "Receiving stations".
4. Adjust the level. Turn the **VOLUME** knob clockwise or press the **UP** button on the remote control to increase the volume level. Turn the knob counterclockwise or press the **DOWN** button on the remote control to decrease the volume level.
5. Adjust to your desired tone. **BASS:** Turn clockwise to boost or counterclockwise to attenuate the bass. **TREBLE:** Turn clockwise to boost or counterclockwise to attenuate the treble. **SELECTIVE TONE CONT:** Press this button to clearly reproduce ultra-low and -high frequencies. The **SELECTIVE TONE** indicator lights up on the display panel.
6. The **BALANCE** knob is used to control the relative volume level of the left and right speaker systems or headphones.

NOTE:

The power does not shut off completely by just turning the power off. The power cord should be removed from the AC outlet when not in use for a prolonged time.

The direct function feature

When a compact disc player and tape deck with the **R1** jack are connected together, you can use the direct function feature. Simply by directly operating the desired component (compact disc player or tape deck), this unit's input selector automatically switches to that component. It is not necessary to switch this unit's input selector when changing listening sources.

Basic operations

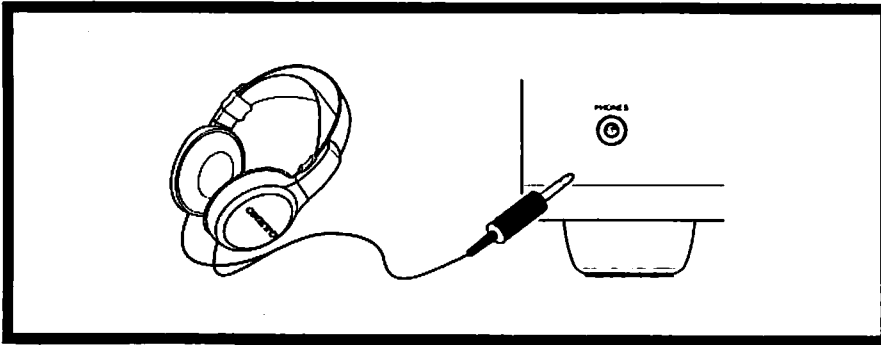

Listening using the headphones

Stereo headphones with a standard binaural (stereo) plug can be connected to the PHONES jack.

When the headphone plug is inserted, the speakers are not automatically muted but can be controlled with the SPEAKERS A/B buttons.

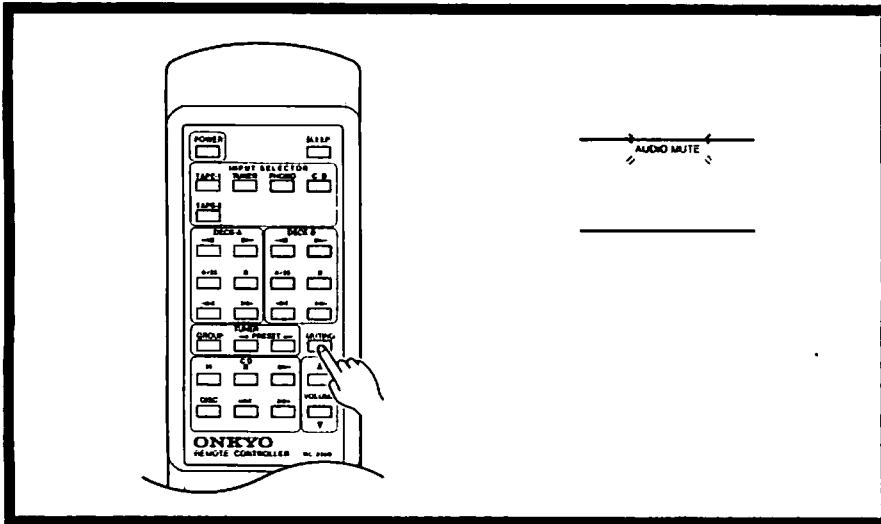

Temporary Muting

Press the MUTING button on the remote control.

This button temporarily switches off the sound from the speakers or headphones.

The AUDIO MUTE indicator will flash.

The muting function will be cancelled if you:

- press the MUTING button again, *or*
- turn the power off then on.

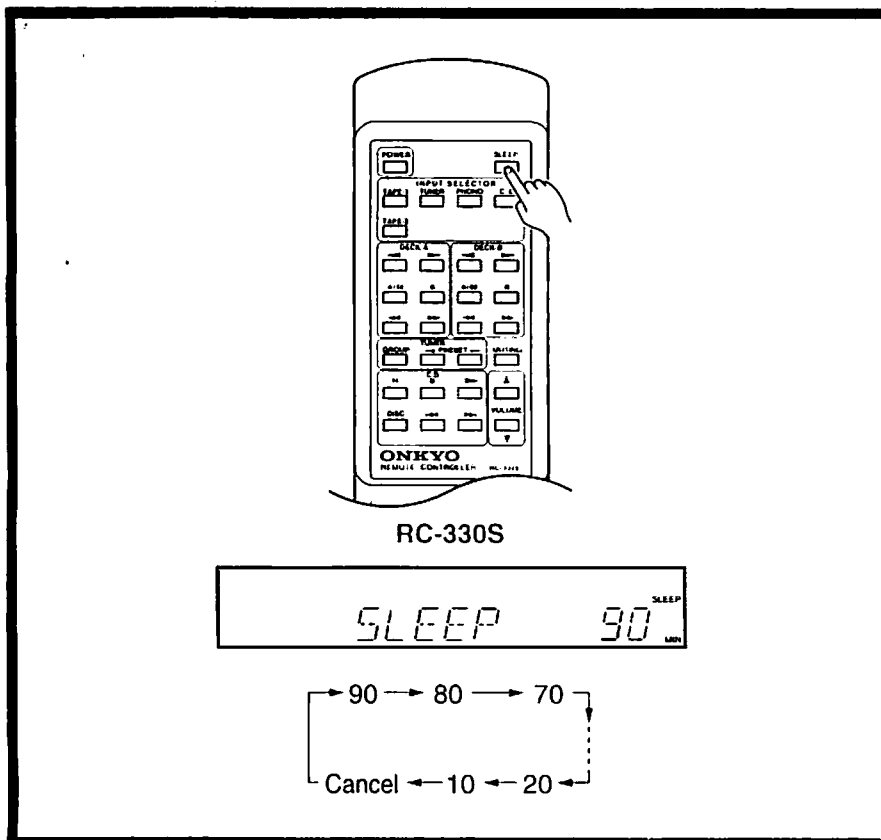

Sleep facility

The sleep timer can power off the system after a specified time period.

To operate this function, use the remote control supplied with your TX-8211.

1. Start the source playing that you would like to listen to (CD, Tape or radio broadcast).
2. Set the amount of time after which you want the system to turn off.

The sleep timer works for up to 90 minutes. You can shorten the timer by 10 minute increments by pressing the SLEEP button until the desired time has been reached.

After the set time passes, the power will be switched off automatically.

Cancelling the SLEEP setting

The timer will be cancelled if you:

- press the SLEEP button until it changes to the display of the source you are listening to, *or*
- turn off the power while the timer is operating.

Receiving stations

Please make sure that the **T-2 MONITOR** and **AUDIO MUTE** indicators are not lit.

Tuning the radio (Manual tuning and Direct tuning)

When the frequency is not known (Manual tuning)

1. Press the FM or AM button.
 2. Use the **DOWN TUNING UP** buttons to change the frequency.
UP.....the frequency increases.
DOWN.....the frequency decreases.
- The frequency is changed in 100 kHz (or 50 kHz) steps in FM and 10 kHz (or 9kHz) in AM each time a tuning selector button is pressed.
 - If a button is held continuously for more than 0.5 seconds, the frequencies are scanned automatically. (FM auto tuning mode)

When a broadcast is received, scanning stops.

When the frequency is known (Direct tuning)

1. Press the FM or AM button.
2. Press the **DIRECT TUNING** button.
The "-- --" will flash for 16 seconds in the frequency display.
3. Enter the frequency with the number buttons while the cursors are flashing.

Example: 88.10 MHz 8 → 8 → 1 → 0/10

- When receiving AM broadcasts with a 9 kHz step (this depends on your region), you can enter the frequency directly.
With 10 kHz steps, entering a number for the 10 kHz digit will set the 1 kHz digit automatically to 0.
- If you enter a frequency that is out of range, this unit will return to the previous frequency. If this happens, repeat the procedure.

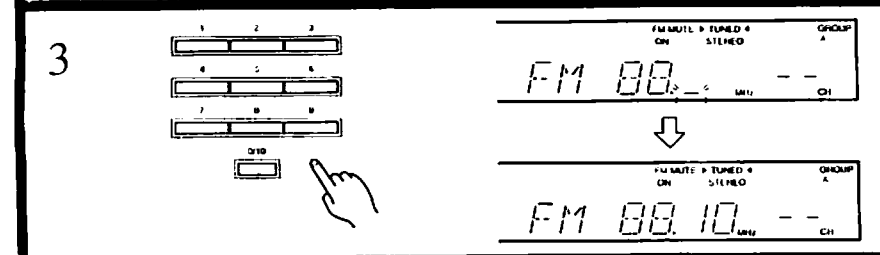
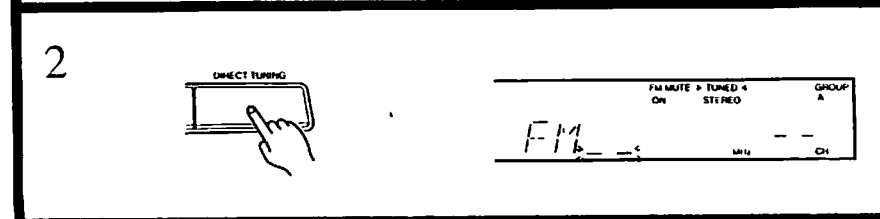
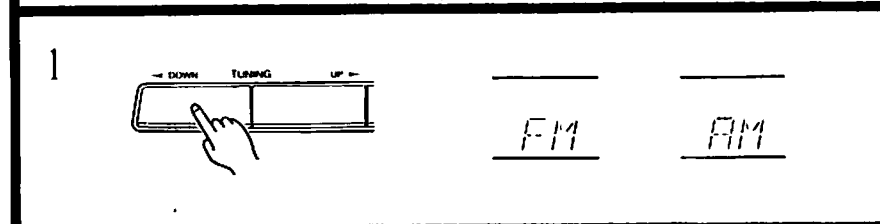
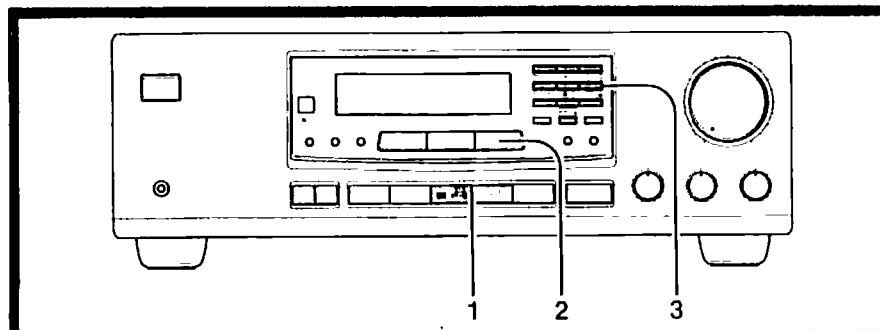
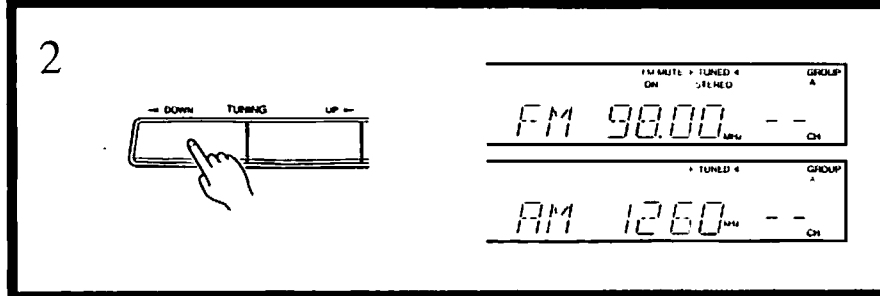
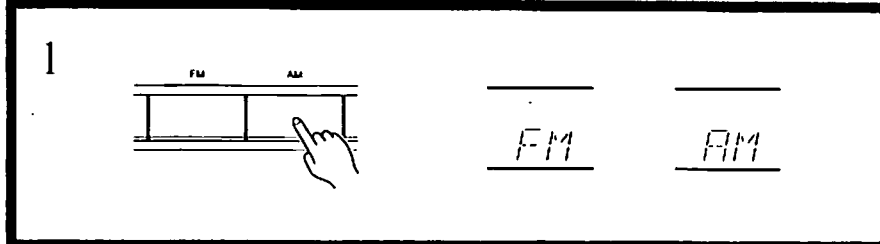
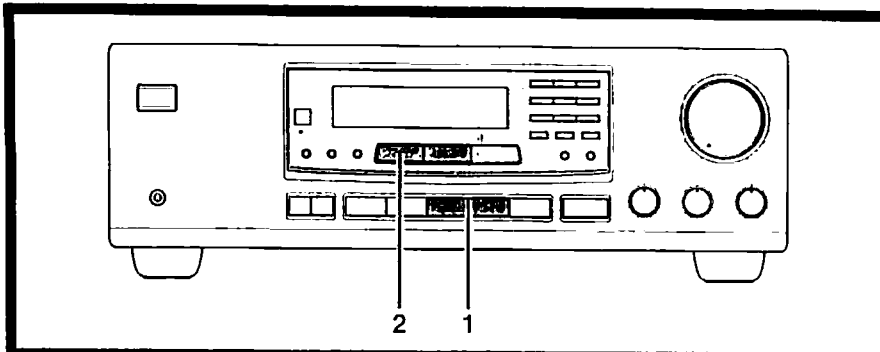

Receiving stations

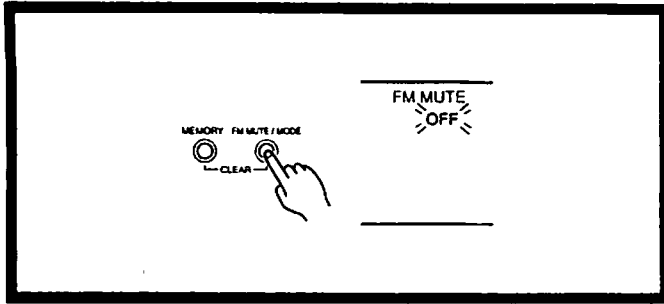

Listening to a stereo radio stations (FM only)

If you tune in a stereo FM station, the STEREO indicator will be illuminated if the signal is sufficiently strong.

If the signal is weak, it may be impossible to tune into your desired station. In this case, tune in as follows.

Press the FM MUTE/MODE button and FM MUTE OFF lights up. At this time, the station will be in mono and interstation noise will be heard.

Select the station you want to listen to.

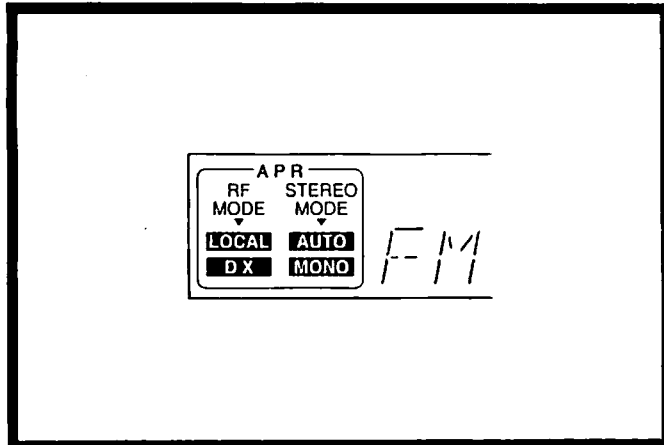

The APR system (FM only)

This unit is equipped with an APR system to help tune in FM stations.

When receiving an FM station using manual or direct tuning, RF MODE LOCAL/DX and STEREO MODE AUTO/MONO settings are made automatically, according to the station being received.

The APR system automatically sets the gain of the RF section to DX or LOCAL according to the quality of the signal being received. The RF MODE will indicate LOCAL when a sufficient signal is received.

If the MONO indicator lights up while a station is tuned in, the station will be received in mono even if it is a stereo station.

The STEREO MODE AUTO/MONO settings that the APR system makes can be changed by pressing the FM MUTE/MODE button.

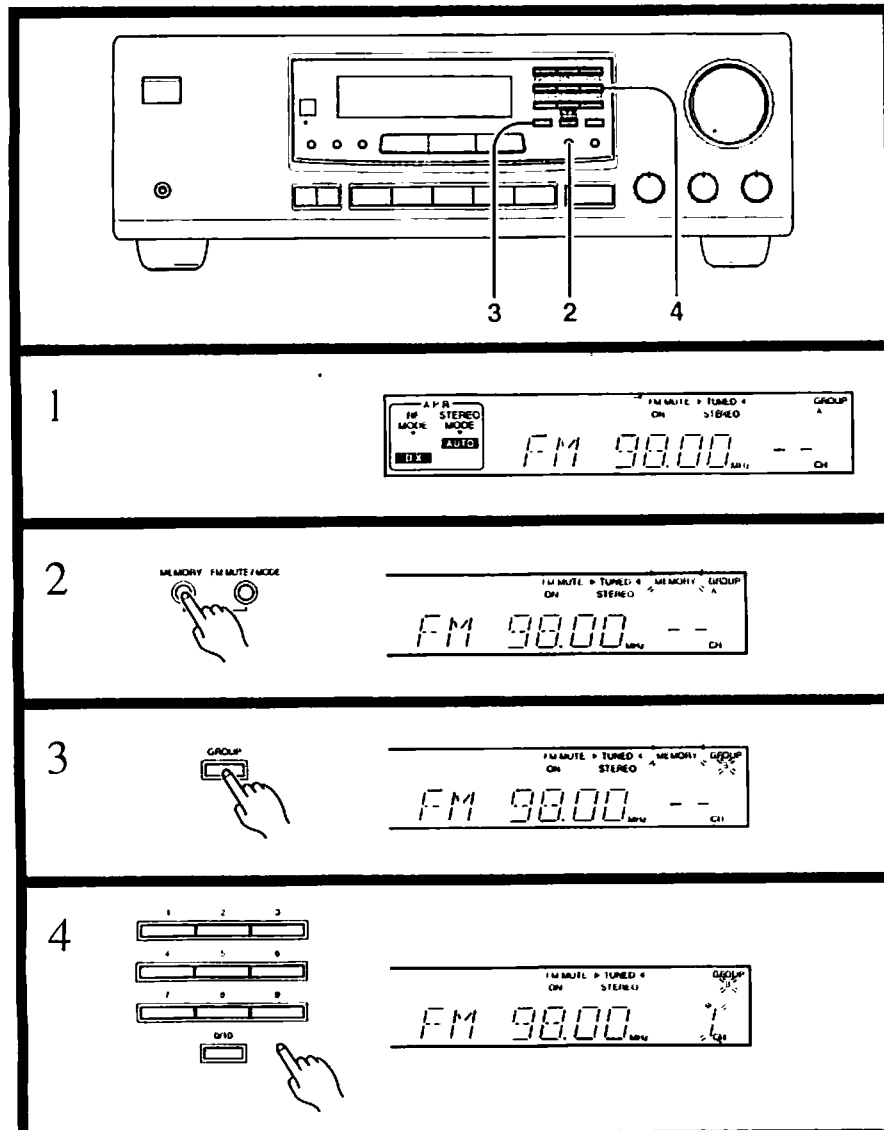

Programming radio stations

Since ten AM or FM stations can be stored in each group (A, B or C), a total of 30 stations can be stored in the memory.

1. Select the frequency that you want to store in the memory.
(Refer to "Tuning the radio" on page 15.)
2. Press the MEMORY button.
The MEMORY indicator will light for 8 seconds.
3. While the MEMORY indicator lights, press the GROUP button to choose the desired group.
The group shown on the display changes in the following order each time the button is pressed: A → B → C → A...
4. Select the desired memory number using the number buttons.
Press button 0/10 when choosing memory number 10.

NOTE:

If the FM station received is an RDS station with a PS (Program Service Name), the frequency display will change to the PS display. If there is no PS, the frequency display will not change.

(Refer to pages 18 and 19 for more details on the RDS function.)

Receiving stations

Selecting preset stations

First, select the tuner as the source by pressing the AM or FM input selector button on the main unit or TUNER input selector button on the remote control.

Main unit

1. Press the GROUP button to select the desired group.
2. Input the memory number you wish to receive by using the number buttons.

or
Press the SCAN button.

Each station stored in the group chosen in step 1 will be received for 5 seconds. When the station that you want is found, press the SCAN button again and scanning will stop.

Remote control

1. Press the GROUP button and choose the group.
2. Press the PRESET ◀ or ▶ button. After the last number of GROUP C is reached, scanning will restart at GROUP A.

Cancelling preset stations

1. Select the station that you want to cancel as explained in the previous section.
2. Press the FM MUTE/MODE button while holding down the MEMORY button. "--" will be shown on the display.

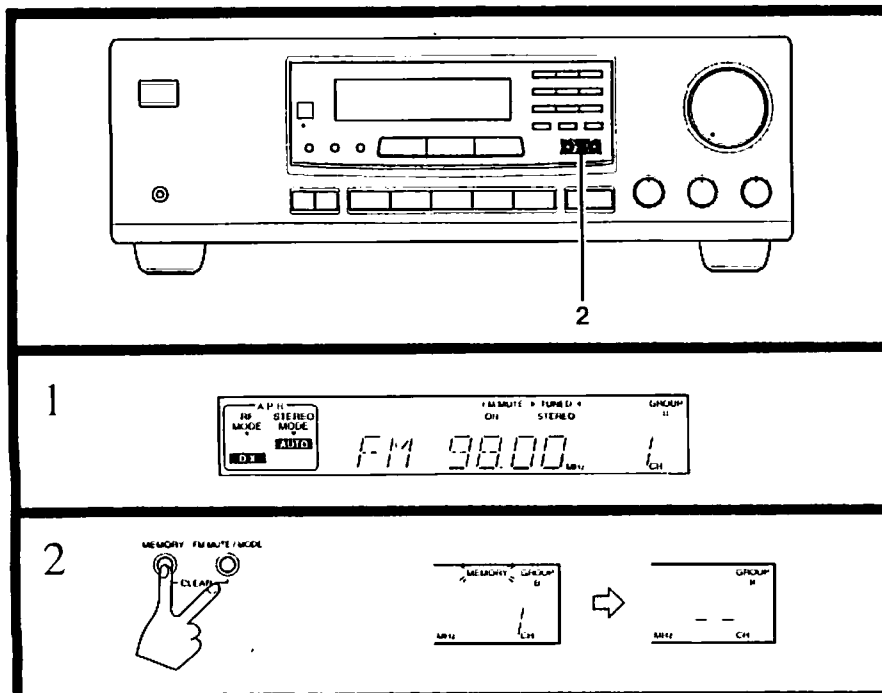
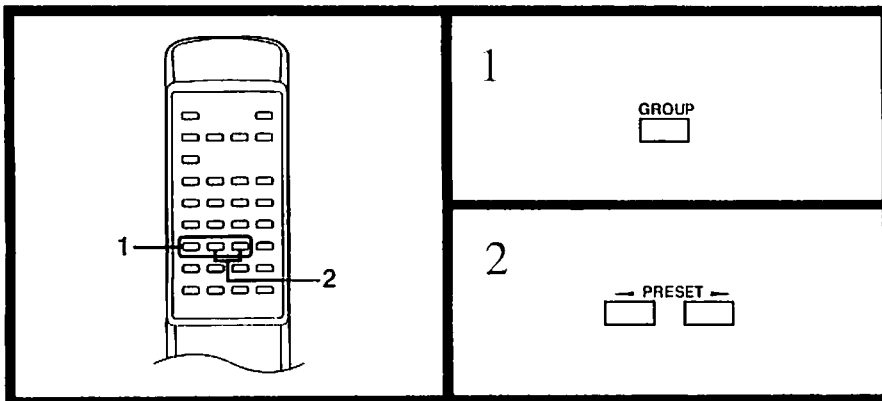
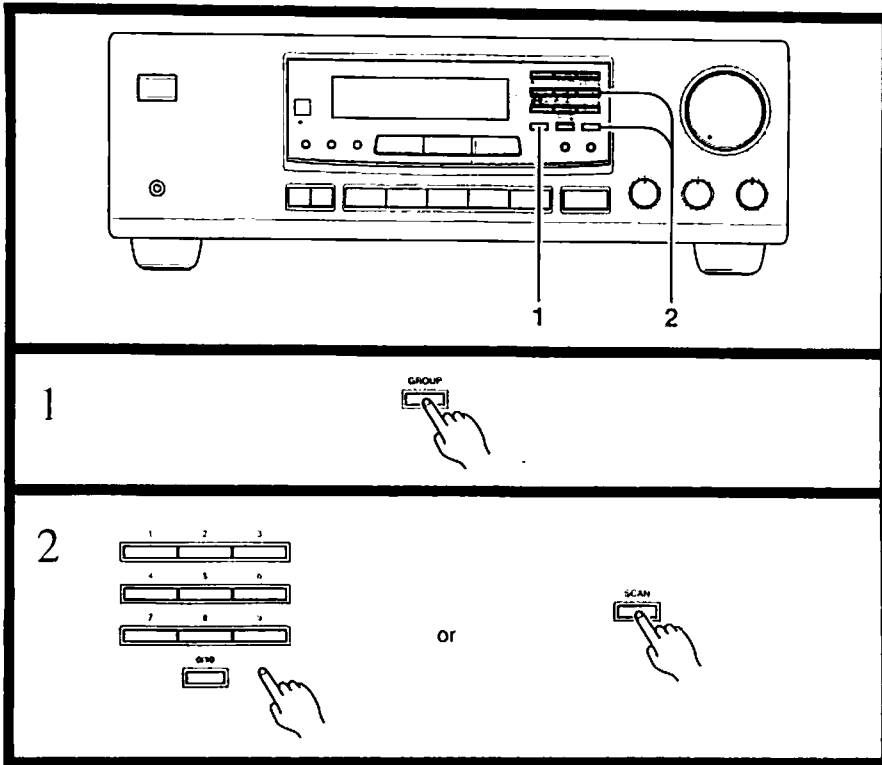

Receiving RDS (Only for European and some other models)

RDS reception is only in areas where RDS broadcasts are available.

What is RDS?

Many FM stations now transmit RDS signals which give additional information. RDS provides you with various services so that, for example, you can choose a station broadcasting your favorite category of music or other information. The information shown at the right is available on this unit.

NOTE:

In some cases, the characters displayed on the display of the TX-8211 may not be exactly the same as the ones broadcast by the radio station. If strange characters appear in the display, it is because characters are being received that cannot be correctly displayed by the TX-8211. They do not indicate a malfunction of the unit.

PS: Program Service Name

PTY: Program Type

TP: Traffic Program

RT: Radio Text

PTY Classifications in Europe

0	NONE	None	No program type or undefined.
1	NEWS	News reports	Reports on current events and happenings.
2	AFFAIRS	Current affairs	Topical reporting of current affairs, often with a wider range of topics than news reports.
3	INFO	Information	General information such as weather forecasts, consumer affairs, medical help, etc.
4	SPORT	Sport	Live sports action, sports news and interviews.
5	EDUCATE	Education	Formal educational programs.
6	DRAMA	Drama	Radio plays and serial.
7	CULTURE	Culture	Cultural programs (including religious affairs).
8	SCIENCE	Science and technology	Programs about the natural sciences and technology.
9	VARIED	Varied	Speech based programs not covered by the above categories, eg. quizzes, panel games, comedy, etc.
10	POP M	Pop music	Popular commercial music, usually included in past or present sales charts.
11	ROCK M	Rock music	Popular music with a more specialist appeal, often not included in sales charts.
12	M.O.R.M	Middle of the road music	Easy listening music as opposed to Pop, Rock or Classical.
13	LIGHT M	Light classics	Classical music for general rather than specialist appreciation.
14	CLASSICS	Serious classics	Performances of major orchestral works, symphonies, chamber music, etc., including Grand Opera.
15	OTHER M	Other music	Music styles not covered by the above categories, eg. Jazz, Rhythm & Blues, Folk, Country, Reggae.

Receiving RDS (Only for European models)

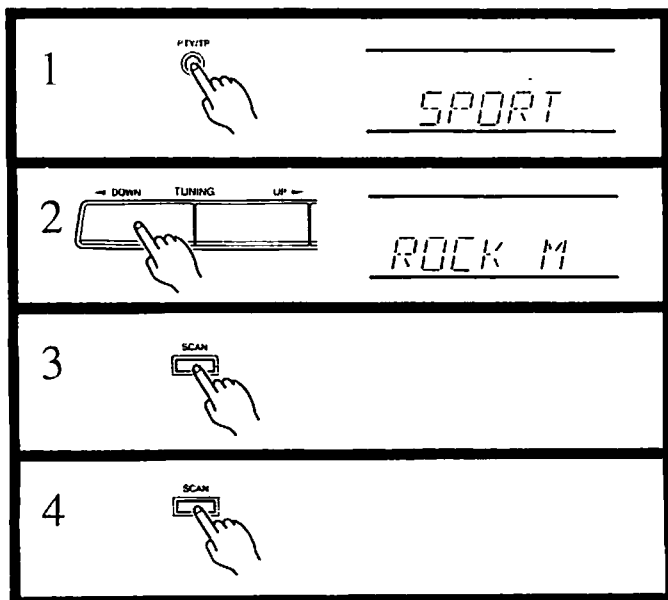
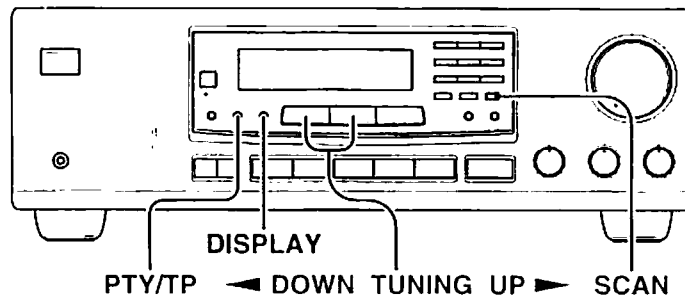

Searching for a station which broadcasts your favorite category (PTY scan)

1. Press the PTY/TP button, to select "PTY".
If the station you are receiving is not broadcasting RDS, "Not RDS" (this is not an RDS station) will be shown on the display.
2. Use the ◀ DOWN TUNING UP ▶ buttons to select the program type (PTY), for example, "ROCK M".
See the PTY description on the previous page.
3. Press the SCAN button to start searching for the chosen PTY station.
When a station is received with the desired PTY, the scanning stops for approximately 5 seconds, before the unit starts scanning again.
4. When the desired station is reached, press SCAN button again to stop scanning.

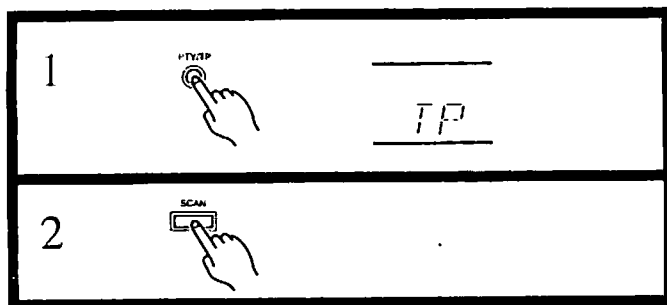

Receiving RDS traffic information

1. Press the PTY/TP button to select "TP".
If *TP* is shown on the display, it indicates that the current station is broadcasting traffic information.
2. Press the SCAN button to start searching for a TP station.
When the unit receives a TP station, it stops scanning. If the unit cannot receive any TP station, "Not find" (cannot find the station) is shown on the display.

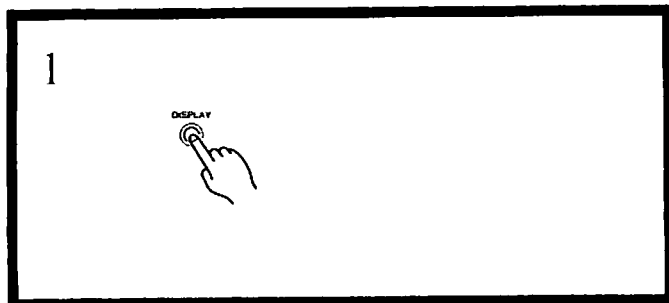

Displaying Radio Text (RT)

If the station you are listening to is not an RDS station, this function cannot be used.

1. Each time you press the DISPLAY button, the display changes as follows.

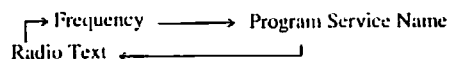

If the current station you are listening to is not an RDS station, only the frequency of the station appears.
When RT is received, it can sometimes take up to 15 seconds (more or less) to show RT on the display.

Sometimes the following messages will be shown on the display.

Wait: When the information is received, the characters will scroll across the display.

No text: This appears for 3 seconds and indicates that even though an RDS station is being received, there is no RT information included.

Recording a source

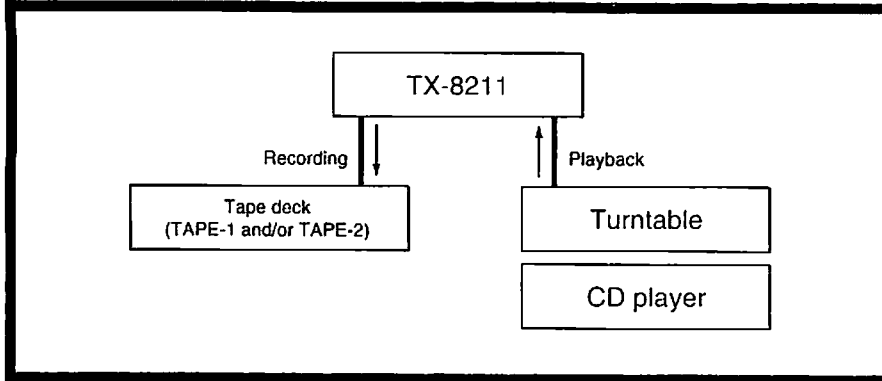
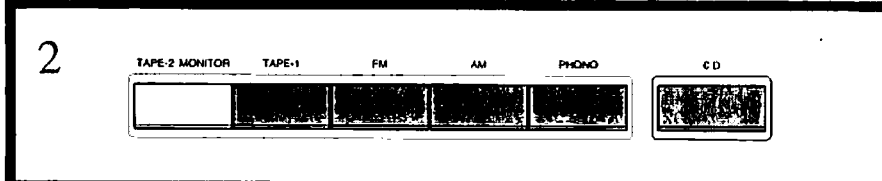
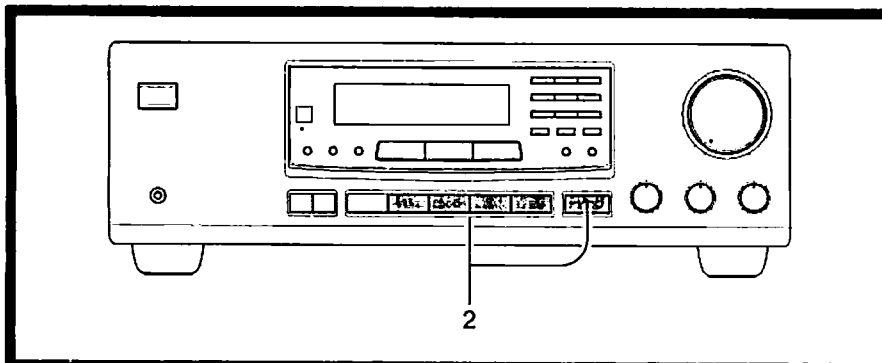

Recording an audio source

Please read the instruction manuals concerning the operation of each unit.

1. Insert a blank tape into the tape deck.
2. Press the button (other than TAPE-2 MONITOR) of the source from which you want to record.
 - When FM or AM is selected, set the tuner to the station you want to record from.
 - When TAPE-1 is selected, it will record to the TAPE-2.
 - When either FM, AM, PHONO or CD is selected, you are able to record to both the TAPE-1 and TAPE-2.
3. Put the tape deck in the recording mode. Begin playing the source.

Set the proper recording level using the controls on the tape deck used for recording. Also, if any controls (bass, treble etc.) on this unit are changed during recording and dubbing operations, the tone effects will not change.

NOTE:

Recording from TAPE-2 to TAPE-1 is not possible.

Tape-to-Tape Dubbing

1. Load the original tape in deck 1 and the blank tape in deck 2.
2. Press the TAPE-1 button.
3. Put tape deck 1 in the playback mode and tape deck 2 in recording mode.

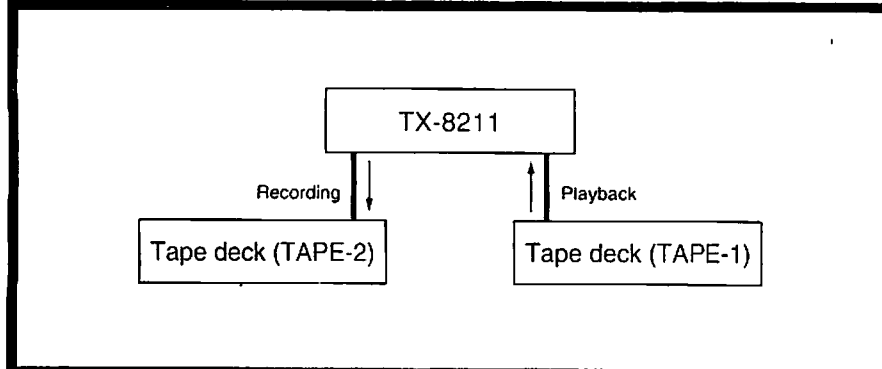
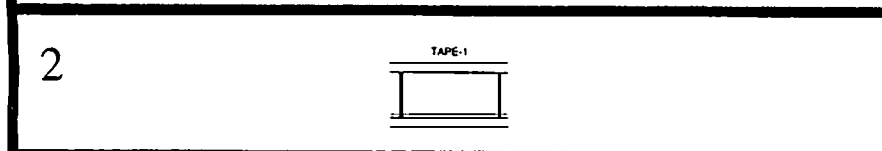
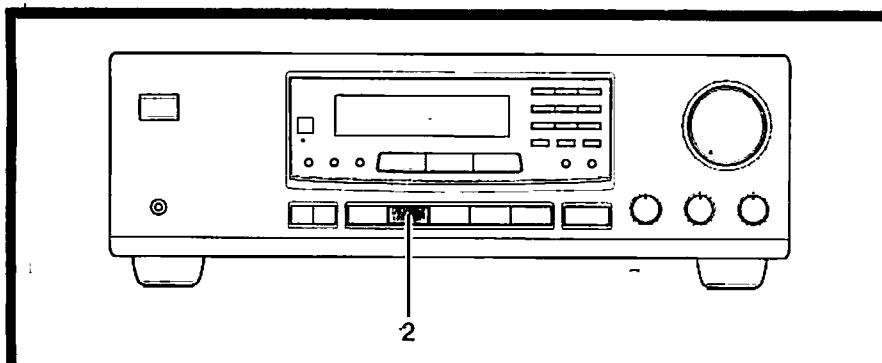

Using TAPE-2 MONITOR

Unless the component connected to the TAPE-2 connectors is to be used, the **T-2 MONITOR** indicator in the main unit's display should not be lit; otherwise, the sound from other sources cannot be heard.

If a 3-head tape deck is connected to the TAPE-2 connectors, TAPE-2 MONITOR can be used to monitor the recording.

NOTE:

Even when TAPE-2 is not selected as the source (the **T-2 MONITOR** indicator is not lit), the source signal is still sent to the TAPE-2 output.

Monitoring during recording

The source signal can be monitored through the speakers or headphones when TAPE-2 MONITOR is turned off.

If the **T-2 MONITOR** indicator in the display is not lit, the sound from the source can be heard. If the 3-head tape deck connected to the TAPE-2 connectors is used for recording, press either the TAPE-2 button on the remote control or the TAPE-2 MONITOR button on the main unit to make "TAPE-2" appear in the display for a few seconds, light up the **T-2 MONITOR** indicator, and hear the sound that is just recorded.

To return to listening to the source sound, press either the TAPE-2 button on the remote control or the TAPE-2 MONITOR button on the main unit and the **T-2 MONITOR** indicator goes off.

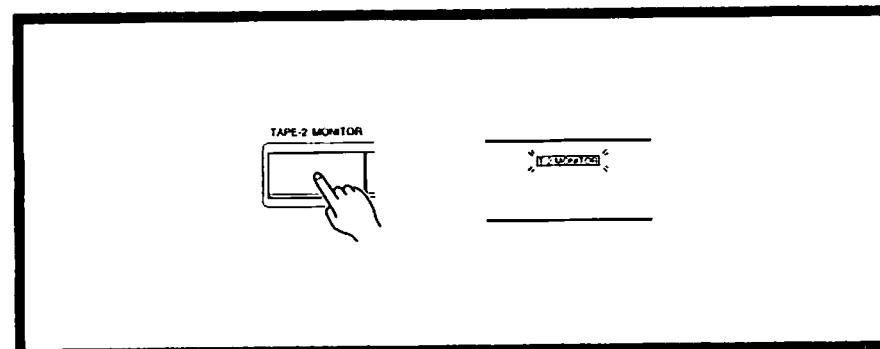
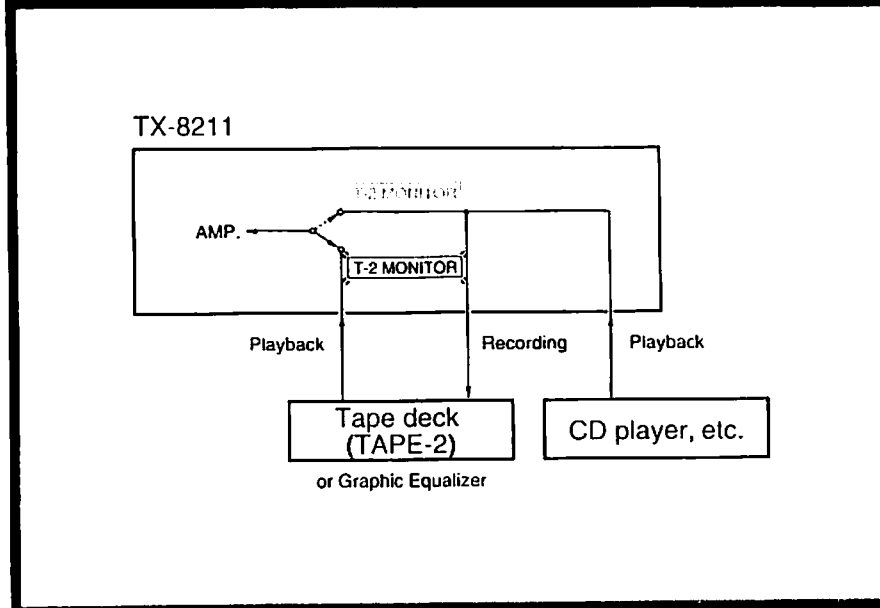
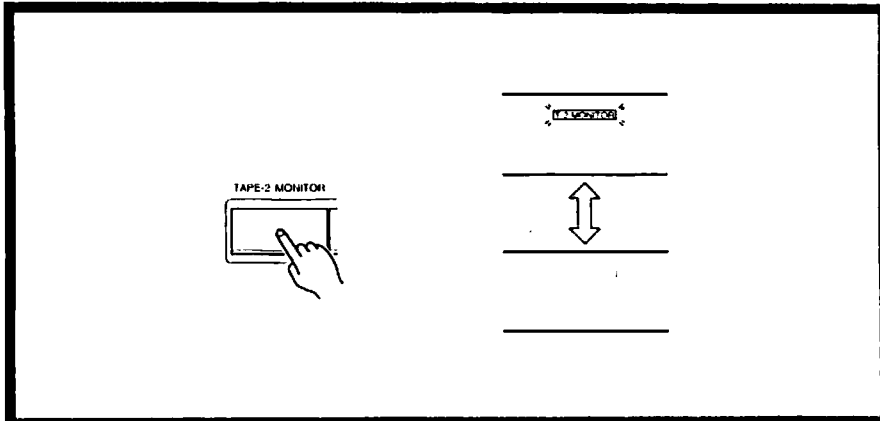

Using a graphic equalizer

1. Connect the graphic equalizer to the TAPE-2 connectors on the rear panel of the TX-8211.
2. If a second tape deck is used, connect it to the tape deck connectors on the graphic equalizer.
3. Press the TAPE-2 button on the remote control or the TAPE-2 MONITOR button on the main unit. The **T-2 MONITOR** indicator on the main unit's display lights up.
4. Follow the operating instructions for the graphic equalizer. To record an equalized signal, use the tape deck connected to the equalizer.

Troubleshooting guide

If a problem occurs, while you are using the remote control, first operate the unit using the front panel controls to confirm that it is not due to a malfunction (or expired batteries) of the remote control.

Trouble	Cause	Remedy
No power	<ul style="list-style-type: none"> Power cord is disconnected. There is external noise in the computer circuits of this unit. AC fuse is blown. 	<ul style="list-style-type: none"> Connect power cord. Turn the power switch off, and then on again or remove the AC plug from the outlet and then plug it again. Contact your Onkyo Service Center.
Power but no sound	<ul style="list-style-type: none"> [T-2 MONITOR] indicator is lit. AUDIO MUTE indicator is lit. Bad/incorrect connections Amplifier protection circuitry has been activated. 	<ul style="list-style-type: none"> Switch off. Switch off with the remote control. Check connection cables, speaker cables, etc. Contact your Onkyo Service Center.
Hum, low-frequency noise	<ul style="list-style-type: none"> Poor or no input ground Poor or no phono motor ground The placement of the audio connection cables on the rear panel is incorrect. 	<ul style="list-style-type: none"> Check outer conductor of input plugs. Check for proper ground connection. Adjust the placement of the cable to reduce hum.
Howling when the volume is turned up	<ul style="list-style-type: none"> Turntable and speakers are too close together. 	<ul style="list-style-type: none"> Move them farther apart.
Rough or scratchy sound; High range is not clear	<ul style="list-style-type: none"> Stylus of turntable pick-up is worn. Turntable stylus tip is dirty. Treble control is too high. 	<ul style="list-style-type: none"> Replace. Clean. Turn treble control down.
AM stations cannot be received.	<ul style="list-style-type: none"> AM loop antenna is not attached. 	<ul style="list-style-type: none"> Connect the included AM loop antenna to the AM antenna terminals.
Buzzing noise on AM (particularly conspicuous at night or with weak stations)	<ul style="list-style-type: none"> Noise from electrical apparatus such as fluorescent lamp 	<ul style="list-style-type: none"> Move the AM loop antenna to a different position. Set up an outdoor AM antenna.
High-pitched noise or buzzing noise on AM	<ul style="list-style-type: none"> Noise from the TV set 	<ul style="list-style-type: none"> Place the AM loop antenna as far as possible from the TV. Move unit away from TV set.
Crackling noise on AM or FM	<ul style="list-style-type: none"> Noise caused by turning fluorescent lamp on and off Noise from automobile ignition 	<ul style="list-style-type: none"> Move antenna as far as possible from the fluorescent lamp. Install an FM outdoor antenna as far as possible from the road. Change the position or direction of the outdoor antenna.
FM TUNED and STEREO indicators light but sound is distorted and stereo separation is bad.	<ul style="list-style-type: none"> Station is too strong. Multiple reflection of the radio waves because of tall buildings or mountains 	<ul style="list-style-type: none"> Change to a T-shaped antenna. Use an antenna which has better directivity and select a point where the distortion is least.
FM TUNED and STEREO indicators flicker and hiss is heard on FM.	<ul style="list-style-type: none"> Station is too weak. Stereo FM broadcasts cover only about half the distance of an ordinary broadcast. 	<ul style="list-style-type: none"> Install an outdoor FM antenna. Change the position or direction of the outdoor antenna.
No station is recalled when a PRESET or SCAN button is pressed.	<ul style="list-style-type: none"> The power cord has been unplugged for a long time. 	<ul style="list-style-type: none"> The memory contents are lost. Store all stations again.
The RDS function does not work.	<ul style="list-style-type: none"> It is not RDS station. The reception station signal is too weak. Too much interference 	<ul style="list-style-type: none"> Receive an RDS station. Install an outdoor FM antenna. Change the position or direction of the outdoor antenna. Move the antenna as far away as possible from the fluorescent lamp. Install an outdoor FM antenna as far away as possible from the road.
Front panel controls function, but remote control does not.	<ul style="list-style-type: none"> No batteries in remote control. Batteries have worn out. 	<ul style="list-style-type: none"> Insert batteries. Replace batteries.

- Also refer to the respective instruction manuals of the CD player, cassette recorder, etc., being used.

Specifications

AMPLIFIER SECTION

Power Output:

USA & Canadian models:	50 watts per channel, min RMS, at 8 ohms, both channels driven from 20 Hz to 20 kHz, with no more than 0.08% THD.
European models:	2 x 70 watts at 4 ohms, 1 kHz (DIN)
Asian models:	2 x 90 watts at 4 ohms, 1 kHz (EIAJ)

Dynamic power output:

USA & Canadian models:	2 x 135 watts at 2 ohms 2 x 105 watts at 4 ohms 2 x 70 watts at 8 ohms
Other area models:	2 x 110 watts at 2 ohms 2 x 90 watts at 4 ohms 2 x 55 watts at 8 ohms

Total Harmonic Distortion: 0.08% at rated power
0.08% at 1 watt output

IM Distortion: 0.08% at rated power
0.08% at 1 watt output

Damping Factor: 60 at 8 ohms

Input Sensitivities and Impedance:

PHONO:	2.5 mV, 50 kohms
Line (CD, TAPE-1, 2):	150 mV, 50 kohms

Output Level and Impedance:

Rec out (TAPE-1, 2):	150 mV, 2.2 kohms
Phono Overload:	120 mV RMS, at 1,000 Hz, 0.5% THD.
Frequency Response:	20 to 30,000 Hz, ± 1 dB
RIAA Deviation:	20 to 20,000 Hz, ± 0.8 dB

Tone Control:

BASS:	± 10 dB at 100 Hz
TREBLE:	± 10 dB at 10,000 Hz

Signal-to-Noise Ratio:

PHONO:	80 dB (IHF A, 5 mV input)
CD/TAPE:	100 dB (IHF A)

Muting: -50 dB

TUNER SECTION

FM:

Tuning Range:

U.S. and Canadian models:	87.50 to 108.00 MHz (100 kHz steps)
European and worldwide models:	87.50 to 108.00 MHz (50 kHz steps)

Usable Sensitivity: Mono: 11.2 dBf, 1.0 μ V (75 ohms IHF)
0.9 μ V (75 ohms DIN)
Stereo: 17.2 dBf, 2.0 μ V (75 ohms IHF)
2.3 μ V (75 ohm DIN)

50dB Quieting Sensitivity: Mono: 17.2 dBf, 2.0 μ V (75 ohms)
Stereo: 37.2 dBf, 20.0 μ V (75 ohms)

Capture Ratio: 1.5 dB

Image Rejection Ratio:

U.S. and Canadian models:	40 dB
Other models:	85 dB

I² Rejection Ratio: 90 dB

Signal-to-Noise Ratio: Mono: 76 dB, IHF
Stereo: 70 dB, IHF

Alternate Channel Attenuation (± 400 kHz):

Mono	55 dB, IHF
	55 dB DIN (± 300 kHz 40 kHz Devi.)

Selectivity:

AM Suppression Ratio: 50 dB

Total Harmonic Distortion: Mono: 0.15%
Stereo: 0.25%

Frequency Response: 30 to 15,000 Hz ± 1.5 dB

Stereo Separation: 45 dB at 1,000 Hz/
30 dB at 100 to 10,000 Hz

Stereo Threshold: 17.2 dBf, 2.0 μ V (75 ohms)

AM:

Tuning Range:

U.S. and Canadian models:	530 to 1,710 kHz (10 kHz steps)
European models:	522 to 1,611 kHz (9 kHz steps)
Worldwide models:	530 to 1,710 kHz (10 kHz steps) 531 to 1,602 kHz (9 kHz steps)

Usable Sensitivity: 30 μ V

Image Rejection Ratio: 40 dB

I² Rejection Ratio: 40 dB

Signal-to-Noise Ratio: 40 dB

Total Harmonic Distortion: 0.7%

GENERAL

Power Supply:

U.S. and Canadian models:	AC120 V, 60 Hz
European and Australian models:	AC230 V, 50 Hz

Worldwide models: AC 220-230/120 V switchable, 50/60 Hz

Power Consumption: 180 W

Dimensions (W x H x D): 435 x 150 x 322 mm

17-1/8" x 5-7/8" x 12-11/16"

Weight: 8.3 kg, 18.3 lbs

REMOTE CONTROL RC-330S

Transmitter: Infrared

Signal range: Approx. 5 meters, 16 ft.

Power supply: Two "AA" batteries (1.5 V x 2)

Specifications and features are subject to change without notice.

ONKYO CORPORATION

Sales & Product Planning Div. : 2-1, Nisshin-cho, Neyagawa-shi, OSAKA 572, JAPAN
Tel: 0720-31-8111 Fax: 0720-33-5222

ONKYO U.S.A. CORPORATION

200 Williams Drive, Ramsey, N.J. 07446, U.S.A.
Tel: 201-825-7950 Fax: 201-825-8150 E-mail: onkyo@onkyousa.com

ONKYO EUROPE ELECTRONICS GmbH

Industriestrasse 18-20, 82110 Germering, GERMANY
Tel: 089 84 93 20 Fax: 089 84 93 226

ONKYO FRANCE

Immeuble Le Diamant, Domaine Technologique de Saclay, 4 Rue René Razel,
91892 SACLAY, FRANCE Tel: (1) 69 33 14 00 Fax: (1) 69 41 35 84

SN 29342370Y



107960